



Rhema Bible Training College

STUDENT HANDBOOK 2024-2025



STRONG FAITH. STRONG FOUNDATION. STRONG FUTURE. RHEMA STRONG.

Published: April 2025

STUDENT HANDBOOK

2024 - 2025





Rhema Bible Training College

2024–2025 Calendar of Events

Term 1: September 16–November 8
Term 2: November 11–January 17
Term 3: January 21–March 14
Term 4: March 24–May 16

SEPTEMBER

S	M	T	W	Th	F	S
1	2	3	4	5	6	7
8	9	10	11	12	13	14
15	16	17	18	19	20	21
22	23	24	25	26	27	28
29	30					

3 Fall Registration—1st Year
4 Fall Registration—2nd Year
5 Fall Registration—3rd Year and Above
6–13 Fall Orientation
16 First Day of Class
26–28 Kindle the Flame® Women's Conference

OCTOBER

S	M	T	W	Th	F	S
		1	2	3	4	5
6	7	8	9	10	11	12
13	14	15	16	17	18	19
20	21	22	23	24	25	26
27	28	29	30	31		

1 Tuition Payment
10–11 Midterm Exams
18–20 Fall College Weekend

NOVEMBER

S	M	T	W	Th	F	S
					1	2
3	4	5	6	7	8	9
10	11	12	13	14	15	16
17	18	19	20	21	21	23
24	25	26	27	28	29	30

1 Tuition Payment
6–7 Final Exams
7–8 A Call to Arms® Men's Conference
11 Term 2 Begins
25–29 Thanksgiving Break

DECEMBER

S	M	T	W	Th	F	S
1	2	3	4	5	6	7
8	9	10	11	12	13	14
15	16	17	18	19	20	21
22	23	24	25	26	27	28
29	30	31				

2 Tuition Payment
10 Christmas Banquet
12–13 Midterm Exams
23–31 Christmas Break

JANUARY

S	M	T	W	Th	F	S
			1	2	3	4
5	6	7	8	9	10	11
12	13	14	15	16	17	18
19	20	21	22	23	24	25
26	27	28	29	30	31	

1–3 Christmas Break
6 Tuition Payment
10 Spring Registration
13–17 Spring Orientation
16–17 Final Exams
20 Martin Luther King Jr. Day
21 Term 3 Begins

FEBRUARY

S	M	T	W	Th	F	S
						1
2	3	4	5	6	7	8
9	10	11	12	13	14	15
16	17	18	19	20	21	22
23	24	25	26	27	28	

3 Tuition Payment
13–14 Midterm Exams
16–21 Winter Bible Seminar

MARCH

S	M	T	W	Th	F	S
						1
2	3	4	5	6	7	8
9	10	11	12	13	14	15
16	17	18	19	20	21	22
23	24	25	26	27	28	29
30	31					

3 Tuition Payment
13–14 Final Exams
17–21 Spring Break
24 Term 4 Begins

APRIL

S	M	T	W	Th	F	S
		1	2	3	4	5
6	7	8	9	10	11	12
13	14	15	16	17	18	19
20	21	22	23	24	25	26
27	28	29	30			

1 Tuition Payment
11–13 Spring College Weekend
17–18 Midterm Exams

MAY

S	M	T	W	Th	F	S
				1	2	3
4	5	6	7	8	9	10
11	12	13	14	15	16	17
18	19	20	21	22	23	24
25	26	27	28	29	30	31

1 Tuition Payment
8–9 Final Exams—Graduating Students
14 Graduate Luncheon
15 Graduation Practice
15–16 Final Exams—1st Year
16 Commencement

JUNE

S	M	T	W	Th	F	S
1	2	3	4	5	6	7
8	9	10	11	12	13	14
15	16	17	18	19	20	21
22	23	24	25	26	27	28
29	30					

JULY

S	M	T	W	Th	F	S
		1	2	3	4	5
6	7	8	9	10	11	12
13	14	15	16	17	18	19
20	21	22	23	24	25	26
27	28	29	30	31		

20–25 Campmeeting

Rhema Bible Training College is under the supervision of Rev. Kenneth W. Hagin, President, and Rev. Lynette Hagin, Director.

Rev. Kenneth W. Hagin
President



Rev. Lynette Hagin
Director



T H E P U R P O S E O F R B T C

Rhema Bible Training College is designed to help fulfill the Great Commission found in Matthew 28:18–20 (NKJV): *“And Jesus came and spoke to them, saying, ‘All authority has been given to Me in heaven and on earth. Go therefore and make disciples of all the nations, baptizing them in the name of the Father and of the Son and of the Holy Spirit, teaching them to observe all things that I have commanded you; and lo, I am with you always, even to the end of the age.’ Amen.”*

Our purpose is to train men and women to fulfill the Great Commission. At Rhema, we teach both the practical and spiritual sides of ministry. We show people how to apply the principles of God’s Word to benefit them personally and fulfill the call God has placed on their lives.

1. RBTC offers courses dealing with all facets of ministry. We endeavor to teach students how to recognize their calling and minister effectively in the office to which God has called them. Classroom instruction is enriched by the ministerial experience of resident instructors and guest speakers.

2. We believe the best training is through precept and example. Rhema Bible Training College is a place where students can become familiar with the Holy Spirit’s gifts and workings. Together, the college and Rhema Bible Church provide an atmosphere where students can see the natural and the supernatural aspects of ministry in operation.

3. Rhema Bible Training College emphasizes the love of God in demonstration, the anointing and presence of the Holy Spirit, the commitment to the integrity of God’s Word, and the necessity for unity of vision and purpose. We feel that understanding and respecting one another as members of the Body of Christ is the key to unity, which is the fundamental element in fulfilling God’s plan. May we each take our place and fulfill our part in this great plan of God.



Welcome to Rhema Bible Training College!

We're glad you're here. You and your classmates have come from all directions—from many different states and countries—for this time. You may have had other plans . . . maybe you weren't even interested in attending a Bible school. You may not realize it, but **it was your Heavenly Father Who drew you here** (Prov. 19:21 NIV), and He's getting ready to do something big in your life!

God wants to take you higher than you ever dreamed and further than you ever imagined. He wants to do greater things through you than you ever thought possible. He brought you here to put something *in you* so you can give *out* to others (Matt. 28:18–20).

But it's up to you. You'll receive from your training here exactly what you put into it—no more and no less. If you diligently apply yourself to your studies and personal devotional life, you'll leave Rhema ready to fulfill all that God has called you to do. But if you become complacent, you'll go in another direction entirely. Remember, you can't give to others what you don't have yourself.

Finally, I want to encourage you to **get involved in school and at Rhema Bible Church.** You'll have many wonderful opportunities to put into practice what you're learning in the classroom. And you'll make some amazing new friends. This is a serious time as you prepare for your future, but it's also a time to laugh and have fun. **We want you to enjoy your time here at Rhema.**

Have a great year! Together, let's determine to press into the things of God and get the most out of every learning experience that is presented.

Yours in Christ,

Kenneth W. Hagin

President

PS. We are here for you! No matter what situations you face, please don't hesitate to talk to our RBTC staff or Rhema Bible Church pastoral staff. We want to see you succeed in every area of life!

General Information	7	Absences	19
Phone Numbers/Contact Information . . .	7	Tardiness	19
Admissions Office Hours	7	Tuition Absences	19
Cancellation of Classes—		Ministry Activities	19
Weather/Holidays	7	Winter Bible Seminar	20
Address/Telephone/Name Changes . . .	7	Student Responsibilities for	
Exaltation and Assembly	7	Attendance	20
Consultation/Appointments	8	Medical and Maternity Leave Limits . . .	20
Housing	8	VA Beneficiary Leave of Absence	20
Job and Housing Postings	8	Attendance Probation and Dismissal . . .	20
Student Activities	8	Graduation Requirements for	
RBTC Activities	8	Second-Year and Advanced	
Rhema Bible Church Activities	8	Studies Students	20
Notifications	8	Rhema School of Music and Media	
Lost and Found	8	Attendance and Grading	21
Medical Emergency Procedures	9	Academic Probation and Dismissal . . .	21
Courses of Instruction	9	Withdrawal	21
First-Year Program	9	Transcripts	22
Second-Year Programs	9	Student Files and Academic Records . . .	22
Advanced Studies Programs	10	Accreditation	22
Advanced Studies General Extended		Transfer of Credits	22
Studies Program	12	Independent Studies	23
Spring Gap Program	12	Rhema Alma Mater	24
Program Change Request	12	Student Policies & Regulations	25
Financial Information	13	Marital/Family Status	25
RBTC Costs	13	Spouse	25
Explanation of Costs	16	Children	25
Tuition Policy	16	Getting Married	25
Returned Check Policy	16	Unpaid Accounts, Rents, and	
VA Benefits	16	Financial Obligations	25
Social Security Benefits	17	Dress Code	26
Financial Aid and Student Loans	17	Student ID Badges	27
Refund Policy	17	Nondiscriminatory Policy	28
Check Cashing	17	Class Visitation Guidelines	28
Third-Party Checks	17	Classroom/Campus Regulations	28
Academic Information	18	Offerings	28
Time and Length of Courses Offered . .	18	Announcements	28
Grading System	18	Audio Equipment/Thermostats	28
Grades	18	Notebook, Laptop, or Tablet	
Cheating	18	Computers	28
Grade Corrections	18	Cell Phones	29
Report Cards	19	Cameras	29
Assignment/Exam Makeup	19	Recording Devices	29
Class Attendance Policy	19	Dry-Erase Boards	29

Class Notes	29	Class MP3 Subscriptions	39
Distractions	29	To Order Class MP3 Subscriptions . .	39
Children	29	To Receive Your Class MP3	
Possession or Use of Weapons.	29	Subscriptions.	40
Flyers/Handbills	29	Weekly Subscriptions	40
Student Mail/Deliveries	29	End-of-Term Subscriptions.	40
Telephone Calls	29	Subscriptions Ordered From	
Classroom Furniture	29	Previous Terms.	40
Rhema Bible Church Emblems	30	Pick-up Deadlines	41
Rhema Park Regulations.	30	Current Class MP3 Information	41
Student Conduct	30	Lost Claim Checks and	
Discipline of Students	31	Defective USB Drives/MP3s.	41
Student Honor Code	31	Seminar Information	41
Sexual and Other Harassment Policy. . .	33	RBTC MP3 Order Form Samples	42
Auto, Traffic & Parking Information.	34	After You Graduate	43
Securing Parking Permits	34	Rhema Alumni Association (RAA)	43
Traffic and Parking Regulations.	35	Rhema Ministerial Association	
Violations and Penalties.	35	International (RMAI)	44
Additional Information	35	Facilities	45
Library Information	36	RCA (Rhema Church Auditorium)	45
Library Hours	36	Rhema Bible Church Office.	45
Library Dress Code	36	RCDC (Rhema Child Development	
Conduct.	36	Center)	45
Library Privileges	36	SDC 1 (Student Development Center 1). .	45
Lost or Damaged Books	36	SDC 2 (Student Development Center 2). .	45
Children	36	Library and Security Office	45
Ninowski Recreation Center (NRC) /		MAC (Multipurpose Activity Center). . . .	45
Sports Activities	37	Administration Building	45
NRC Hours.	37	RMA (Rooker Memorial Auditorium) . .	45
Gym Use	37	NRC (Ninowski Recreation Center) . . .	45
Intramural Sports Program	37	We-Care Center.	45
NRC Skating Rink	38	FAC (Fellowship Activity Center)	45
Student MP3 Information	38	RSH (Rhema Student Housing).	45
General Guidelines for Ordering		Motorcycle Parking	45
Class MP3s	38	MSC (Maintenance Service Center). . . .	45
Where and When to Order.	38	Campus Maps and Classroom Seating . . .	46
What You May Order	38	Kenneth Hagin Ministries Campus Map . .	46
How to Order.	38	Student Development Center 1 (SDC 1). .	47
Individual Class MP3s.	39	Student Development Center 2 (SDC 2). .	47
To Order Individual Class MP3s	39	Rhema Bible Church	
To Receive Your Individual		Auditorium (RCA) Upstairs.	49
Class MP3s	39	Rhema Kids Auditorium.	49

1. PHONE NUMBERS/CONTACT INFORMATION

- Rhema918-258-1588
- Admissions Office..... ext. 2260
- Alumni Office ext. 2256
- Bookstore (RCA)..... ext. 2261
- Church Office ext. 2314
- Music Department ext. 2291
- Ninowski Recreation Center..... ext. 2301
- Photography ext. 2297
- Student Ministries..... ext. 2295
- Rhema Child Development Center (RCDC) 918-258-0594
- Security Office918-607-1289
- Student Housing.....918-258-2440
- Emergency Number (24 hours)918-607-1289**

2. ADMISSIONS OFFICE HOURS—The Admissions Office is open Monday through Friday from 8:15 a.m. to 4:30 p.m. during the school year and 8:30 a.m. to 4:30 p.m. during the summer and school holidays. The in-person windows close at 12:30 p.m. each day, but the Admissions staff is available by phone or email after that time. The Admissions Office closes for Exaltation on Tuesday from 10:10 to 11:10 a.m. On occasion, the Admissions Office may close for special events.

3. CANCELLATION OF CLASSES—WEATHER/HOLIDAYS Students should assume classes are being held unless an official announcement stating classes are canceled is made on Populi and Canvas or via the local news stations listed below. Students should not call the stations, RBTC, or Rhema Security to inquire about class cancellation. You can also check the RBTC Instagram account (@rbtc_usa) or the RBTC Facebook page (@rbtcusa).

- KJRH-Channel 2—Television—kjrh.com
- KOTV-Channel 6—Television—newson6.com
- KTUL-Channel 8—Television—ktul.com
- KOKI-Channel 23—Television—fox23.com
- KRMG-FM 102.3; KRMG-AM 740—Radio—krmg.com

Some public schools may observe holidays not observed by RBTC. Please refer to the RBTC calendar at the front of the handbook.

4. ADDRESS/TELEPHONE/NAME CHANGES—Students making address/telephone/name changes MUST notify the Admissions Office immediately using the **Change of Information** form, which can be found at the Forms Table in the lobby of SDC 1.

5. EXALTATION AND ASSEMBLY—Attendance is **required** at all Exaltations and Student Assemblies.

- A.** Each Tuesday and Thursday at 10:30 a.m., all students are required to meet for 30 minutes or until dismissed.
- B.** Exaltation is held on Tuesday. It meets in the RCA and provides students with a time of praise, worship, and prayer.
- C.** Assembly is held on Thursday and usually meets in SDC 1. During this session, special announcements are made, and necessary student business is conducted. Students are responsible for all information given during these sessions.

- D. Students who skip Exaltation or Assembly will be disciplined by the dean or his appointed representatives by being placed on attendance probation for the following four weeks. Continued violations could be cause for dismissal.

6. CONSULTATION/APPOINTMENTS

- A. Informal conversations after or between classes is not the time to ask doctrinal questions.
- B. If a matter is school-related and/or pertains specifically to a class, a student may request an appointment with a faculty member or the dean by submitting a Student Consultation Request Form to the Admissions window or in the Admissions drop box. **Do not** use social media platforms to communicate these sort of requests.

Note: Students should first email the instructor class related questions through Canvas before requesting an appointment.

- C. When requesting a consultation with a member of the pastoral staff, students who attend Rhema Bible Church regularly and consider Rhema Bible Church their home church should go to the Church Office in the RCA, West Hallway.
- D. If a student who does not regularly attend Rhema Bible Church wants to receive spiritual or personal guidance, they should go to the local church that they attend.

- 7. **HOUSING**—All students are responsible for finding and providing their own housing.

8. JOB AND HOUSING POSTINGS

- A. Job and housing postings are made available to current and accepted students through the Populi newsfeed. Only active Populi users can view this information through the Populi website (rbtc.populiweb.com) or on a mobile device using the Populi app.
- B. If using the app, be aware that **only the first five pinned or most recent postings are visible**. To see all current postings, you must log in to your Populi account using the website.
- C. All postings must be approved by the Admissions Office and are posted for 30 days before being removed. Email your ad to rbtc@rhema.org to request posting.

9. STUDENT ACTIVITIES

- A. **RBTC Activities**—RBTC sponsors many student activities, including monthly late skates and family skates. Throughout the year, several special events are planned, such as the Orientation Week festivities, international and class group functions, and the Christmas Banquet, etc.
- B. **Rhema Bible Church Activities**—School of the Bible classes and LINK Teams provide many fellowship opportunities at Rhema Bible Church. These include class breakfasts, luncheons, dinners, picnics, sports outings, holiday activities, drama and musical plays, sightseeing trips, and retreats. Young adult/singles ministry is available through YA and Synergy. Rhema also offers extensive ministry to youth through our children's and Rhema Youth programs.

In addition, Rhema Bible Church has several special events each year, including the men's and women's conferences. These events are announced in School of the Bible classes, in the church bulletin, and during church services.

- C. **Notifications**—You will not miss any scheduled school activities if you pay attention during Thursday announcements. Announcements are also posted on Canvas.

- 10. **LOST AND FOUND**—Located in the SDC 1 lobby across from the Admissions windows. All items are removed the last day of each term. We are not responsible for any items placed in or taken from Lost and Found.

1. Do not move the patient unless their life is in danger.
2. Have someone stay with the patient until help arrives.
3. **A.** If the situation is acute or life threatening, call 911 first—then call Rhema Security at 918-607-1289.
- B.** If the situation is *not* acute or life threatening, call Rhema Security. Tell them your name, exact location, and a brief description of the problem. Do not hang up until told to do so. Rhema Security will contact the proper emergency services. Meet Rhema Security to guide them to the patient.

COURSES OF INSTRUCTION

FIRST-YEAR PROGRAM

Angels and Demons Bible Doctrines 1 Bible Interpretation Blood Covenant Christ the Healer Critical Thinking Dispensational Truths Ephesians Faith Library 1	Financial Management Gifts of the Spirit Gospel of John Holy Spirit Introduction to World Missions Marriage, Family, and Ministry New Testament Survey Old Testament People of Faith Old Testament Survey	Pentecostal and Charismatic Perspectives Principles of Prayer Righteousness Spiritual Growth Principles Submission and Authority Understanding Grace
---	---	---

SECOND-YEAR PROGRAMS

<i>Ministry Fundamentals—</i> Acts Believer’s Authority Bible Doctrines 2 Biblical Perspective of Helps Ministry Christianity and World Religions Church History Doctrine of the Church Faith Library 2	Galatians Introduction to Pastoral Care Life of Honor Ministerial Ethics Minister’s Heart Ministry Gifts Pastoral Epistles People Skills Personal Evangelism	Psalms Pulpit Speech Redemptive Realities Romans Spiritology Spiritual Leadership Principles Wisdom Literature
--	--	--

Rhema reserves the right to add or change a course at any time prior to or during the school year.

Pastors Ministry—

Believer's Authority
 Bible Doctrines 2
 Biblical Perspective of
 Helps Ministry
 Church Administration
 Church History
 Church Planting
 Doctrine of the Church

Effective Pastoring
 Faith Library 2
 Introduction to Pastoral Care
 Legal and Business Issues
 Life of Honor
 Media and Ministry
 Ministerial Ethics
 Minister's Heart

Pastoral Epistles
 Pastors' Lab 1 & 2
 People Skills
 Pulpit Speech
 Redemptive Realities
 Romans
 Spiritology
 Spiritual Leadership Principles

Itinerant Ministry—

Acts
 Believer's Authority
 Bible Doctrines 2
 Biblical Perspective of
 Helps Ministry
 Christianity and World Religions
 Church History
 Doctrine of the Church
 Faith Library 2

Introduction to Pastoral Care
 Itinerant and Helps Ministry Lab
 Itinerant Minister
 Life of Honor
 Ministerial Ethics
 Minister's Heart
 Ministry Gifts
 Pastoral Epistles
 Pastors' Lab 2

People Skills
 Pulpit Speech
 Redemptive Realities
 Romans
 Spiritology
 Spiritual Leadership Principles
 Wisdom Literature

ADVANCED STUDIES PROGRAMS**Rhema School of
Biblical Studies—**

Colossians
 Daniel and Revelation
 Exodus
 Ezekiel
 Ezra–Esther
 First and Second Peter
 First and Second Samuel
 First and Second Thessalonians
 First Corinthians

First Kings–Second Chronicles
 First and Second Peter
 First and Second Samuel
 First and Second Thessalonians
 Genesis
 Hebrews
 Isaiah
 James and Jude
 Jeremiah–Lamentations

Johannine Epistles
 Joshua–Ruth
 Leviticus–Deuteronomy
 Methods of Bible Study
 Minor Prophets 1
 Minor Prophets 2
 Philippians
 RSBS Final Project
 Second Corinthians

***Rhema School of
Pastoral Ministry—**

Advanced Church Planting
 Project
 Basics of Student Ministries
 Building a Staff and Team
 Caring for People God's Way
 Church Administration
 Church Ordinances

Church Planting
 Church Practicum
 Creative Teaching Principles
 Effective Pastoring
 Ezekiel
 Judeo-Christian Study
 Keys to Supernatural Ministry

Legal and Business Issues
 Marketing and Ministry
 Ministerial Navigation
 Missions and the Local Church
 Pastoral Forum
 Sermon Development and Delivery

Rhema reserves the right to add or change a course at any time prior to or during the school year.

***Rhema School of
Music and Media—**

Audio 1	Motion Graphics 2	Social Media 2
Audio 2	Music Fundamentals	Stage Design/Lighting
Audio 3	Music Theory 1	Technical Worship Skills
Church Filmmaking	Music Theory 2	Video Lab
Church Practicum	Part Writing	Videography 1
Church Video Project	Practical Church Leadership	Videography 2
Creative Music	Praise and Worship in the Word	Videography 3
Graphic Design	Service Production 1	Voice/Vocal Skills
Heart of the Worshiper	Service Production 2	
Motion Graphics 1	Social Media 1	

Equipment provided: MacBook and various software

***Rhema School of
World Missions—**

The Apostle Paul and Missions	International Internship Preparation	Missionary Strategies
Effective Cross-Cultural Ministry 1 & 2	International Internship (Term 4)	The Missionary's Stateside Office
Effective Partner Communications 1 & 2	Leadership and Team Development	Missions Symposium 1 & 2
History of Missions	Message Development and Delivery 1 & 2	Preparation for Missions 1, 2 & 3
		Support Raising in Missions

***Rhema School of
Student Ministries—**

Child Development	Leadership in Student Ministries	Student Ministries Internship 1
Children's Lab	Leading Volunteers	Student Ministries Leadership
Colossians	Marketing and Ministry	Youth and Children's Events and Activities
Creative Teaching Principles	Media and Ministry	Youth Development
Elementary Ministry	Methods of Bible Study	Youth Lab
Genesis	Missions and the Local Church	Youth Ministry
Great Themes in Evangelistic Preaching	Nursery and Preschool Ministry	Youth Ministry Curriculum
Keys to Supernatural Ministry	Practical Ministry Skills	
Kids Ministry Curriculum Development	Specialized Issues in Student Ministries	

**Rhema School of
Itinerant Ministry—**

Basics of Student Ministries	Genesis	Ministerial Navigation
Building a Staff and Team	Great Themes in Evangelistic Preaching	Missions and the Local Church
Colossians	Itinerant Minister	Philippians
Church Administration	Judeo-Christian Study	Practical Ministry Skills
Church Ordinances	Keys to Supernatural Ministry	RSIM Lab 1 & 2
Creative Teaching Principles	Legal and Business Issues	Sermon Development and Delivery
Daniel and Revelation	Marketing and Ministry	
Ezekiel	Media and Ministry	
First and Second Peter		

Rhema reserves the right to add or change a course at any time prior to or during the school year.

**Rhema School of
Helps Ministry—**

Advanced Church Planting Project	Ezekiel	Media and Ministry
Basics of Student Ministries	First and Second Samuel	Methods of Bible Study
Church Administration	Helps Ministry Practicum 1 & 2	Ministerial Navigation
Church Planting	How-to of Volunteers	Missionary Family
Colossians	Judeo-Christian Study	Missions and the Local Church
Creative Teaching Principles	Legal and Business Issues	Pastoral Forum 1–4
Effective Pastoring	Marketing and Ministry	Practical Ministry Skills
		RSHM Final Project

*Only available starting in the fall enrollment.

ADVANCED STUDIES GENERAL EXTENDED STUDIES PROGRAM

Complete 24 courses of your choice from any of RBTC's programs (excluding Rhema School of World Missions, Rhema School of Music and Media, Rhema School of Student Ministries, and Rhema School of Pastoral Ministry). **Note:** Monday-Wednesday-Friday classes are 1.5 semester credit hours. Tuesday-Thursday classes are 1 semester credit hour.

SPRING GAP PROGRAM

Complete 12 designated courses of Rhema School of Biblical Studies or General Extended Studies during the spring term. This program allows students who finish their academic year in January to remain active between the end of their year and the beginning of the next fall term enrollment.

PROGRAM CHANGE REQUEST

The deadline for requesting a group or program change is August 15 for fall enrollment and December 15 for spring enrollment. A \$25 fee is assessed for requests received after July 15 or November 15, respectively.

Rhema reserves the right to add or change a course at any time prior to or during the school year.

1. RBTC COSTS

A. First and Second Year

- (1) Total cost is \$3,150
- (2) Cost breakdown

General fee (nonrefundable)	\$550
Tuition	\$2,100
Books (nonrefundable)	\$500
- (3) Tuition is generated for each successive term when a student is enrolled in courses for that term. Tuition cost for each term is \$525 (\$2,100/4). You may pay in advance if you wish. Any credit balance will be applied to future amounts as they become due.
- (4) Payment schedule*

**Payment schedule does not apply to international students.*

Those making the minimum Registration Day payment of \$1,350 must pay the remaining tuition balance according to the schedule given below:

Fall enrollment—

October 1	\$300
November 1	\$300
December 1	\$300
January 1	\$300
February 1	\$300
March 1	\$300

Spring enrollment—

February 1	\$300
March 1	\$300
April 1	\$300
May 1	\$300
September 1	\$300
October 1	\$300

- (5) The minimum registration payment of \$1,350 is applied as follows:

General fee	\$550
Tuition	\$300
Books	<u>\$500</u>
	\$1,350

B. Advanced Studies Programs (See exceptions below.*)

- (1) Total cost is \$3,265
- (2) Cost breakdown

General/activities fee	\$665
Tuition	\$2,100
Books	\$500

(3) Tuition is generated for each successive term when a student is enrolled in courses for that term. Tuition cost for each term is \$525 (\$2,100/4). You may pay in advance if you wish. Any credit balance will be applied to future amounts as they become due.

(4) Payment Schedule

Those making the minimum Registration Day Payment of \$1,465 must pay the remaining tuition balance according to the schedule given below:

Fall enrollment—

October 1	\$300
November 1	\$300
December 1	\$300
January 1	\$300
February 1	\$300
March 1	\$300

Spring enrollment—

February 1	\$300
March 1	\$300
April 1	\$300
September 1	\$300
October 1	\$300
November 1	\$300

(5) The minimum registration payment of \$1,465 is applied as follows:

General Fee	\$665
Tuition	\$300
Books	<u>\$500</u>
	\$1,465

C. RSWM*

(1) Total cost is \$3,265

(2) Cost breakdown

General/activities fee	\$665
Tuition	\$2,100
Books	\$500

(3) Payment schedule

*The full amount of \$3,265 must be paid on Registration Day.

D. RSMM*

(1) Total cost is \$4,750 or \$5,050 with upgraded MacBook

(2) Cost Breakdown

General/activities fee	\$665
Tuition	\$2,100
Books, software & equipment	\$1,985 or \$2,285 with upgraded MacBook

(3) Payment schedule

August 15	\$1,985 or \$2,285 depending on MacBook option
Registration Day	\$965
October 1	\$300
November 1	\$300
December 1	\$300
January 1	\$300
February 1	\$300
March 1	\$300

(4) The minimum total payment due by registration is applied as follows:

General/activities fee	\$665
Tuition	\$300
Books, software & equipment	<u>\$1,985 or \$2,285</u>
	\$2,950 or \$3,250

E. Spring Gap

(1) Total cost is \$1,200

(2) Cost Breakdown

Tuition	\$1,050
Books	\$150*

*Textbook costs are subject to change based on course selection.

(3) Payment schedule

January 8	\$300
February 1	\$300
March 1	\$300
April 5	\$300

Students who complete the Spring Gap Program after their second year and then enroll in an Advanced Studies program (other than RSBS) in the fall will owe \$1,465 on Registration Day. Fees and payments will follow the normal payment schedule as outlined in Section B.

Students who choose to complete the RSBS program (Terms 1 and 2) after completing the Spring Gap Program will owe \$1,465 on Registration Day. This payment covers the remainder of the textbook fees, general fees for the school year, and September tuition. The next tuition payment of \$300 is due on October 4. The final tuition payment of \$300 is due on November 1. This completes the tuition and fees for the full RSBS program (\$3,265), which concludes in January.

F. Possible Additional Fees

Deferral fee—U.S.	\$50
Deferral fee—International	\$150
Grade Correction fee	\$5
Individual Class MP3	\$5
Late assignment/exam fee	\$15
Late grade correction fee	\$10
Late photo makeup fee	\$10
Late registration fee	\$50
Parking violation fine	\$5
Replacement badge fee	\$8
Returned check fee	\$25
Temp ID badge fee	\$2

2. EXPLANATION OF COSTS

A. General Fee

The nonrefundable fee includes such expenses as the NRC gym membership, a student yearbook, Christmas Banquet tickets, administration fees, and parking permits.

B. Tuition

The charge for teaching or instruction. **Tuition is payment for services rendered; therefore, it is not tax-deductible.**

C. Books

The book fee covers all books required for the school year. This fee is nonrefundable.

3. TUITION POLICY

- A. Tuition is due and payable on the first day of each month and then becomes past due. Past due tuition will be accepted until the 10th of the month.
- B. Checks are not an accepted form of payment for tuition after the 10th of the month.
- C. You will not be allowed to attend class after the 10th of the month if your tuition is not paid. You will be automatically suspended from school on the 15th day of the month for nonpayment of tuition.
- D. Any absences accumulated during the suspension will apply against your allowed absences.
- E. If a student leaves RBTC with an outstanding account, we will not recommend that student for any position, either secular or ministerial. We will not mail out transcripts, diplomas, verifications, etc. for students with an outstanding debt to the school.

4. RETURNED CHECK POLICY

- A. **The issuance of insufficiently funded checks will not be permitted.** Students writing bad checks to RBTC or any other party are subject to immediate suspension or dismissal.
- B. A \$25 charge is made for **each** insufficiently funded check. Each returned check must be redeemed with another form of payment.
- C. If you write an insufficiently funded check for tuition, you may be counted absent from the day the check is written until the day your tuition is paid.
- D. Be sure your check is good when you write it. Do not write “faith” checks to anyone. (Most banks put a hold on any checks deposited for collection.)

5. VA BENEFITS—RBTC is approved to offer training and education to eligible veterans, spouses, and their dependents and is compliant with Public Law 115-407, The Veterans Benefits and Transition Act of 2018.

Please contact Veterans Affairs at 1-888-GIBILL1 (1-888-442-4551) or va.gov to see if you qualify for veterans' benefits.

All military transcripts and previous schooling transcripts must be requested and sent to RBTC prior to certification. If transcripts are **not** received by RBTC, certification **cannot** be initiated.

Eligible veterans who have been disabled during their time in the military service may apply for VA benefits through the Veteran Readiness and Employment Benefits to help pay for tuition and related costs. Please contact your local VA representative for qualifications and additional information for the Veteran Readiness and Employment Benefits.

Note: RSWM, General Extended Studies, and Spring Gap programs are not approved for VA benefits.

6. SOCIAL SECURITY BENEFITS—RBTC is not approved for Social Security benefits.

7. FINANCIAL AID and STUDENT LOANS

- A.** Every student receives a 70% “scholarship” because of the generous monthly giving of Rhema Word Partners, greatly reducing the cost to the student!
- B.** According to the IRS “an eligible educational institution is a college, university, vocational school, or other post-secondary educational institution that is described in section 481 of the Higher Education Act of 1965; **and** that is eligible to participate in the Department of Education’s student aid programs.” Since RBTC cannot participate in federal funding (student aid programs), we are not eligible for tuition tax deductions. Tuition payments are the charges for teaching or instruction. These payments are for services rendered; therefore, they are not tax deductible.
- C.** While we are not approved for government loans, qualifying students who want to schedule their tuition payments over a longer period of time may apply for a student loan through the financial institution of their choice.

8. REFUND POLICY

- A.** If you withdraw for any reason from Rhema Bible Training College after you have registered as a student, the tuition will be prorated and the refund will be mailed to you within 30 days.
- B.** No refund will be given for the application fee, general fee, or books.
Note: VA beneficiaries are exempt.
- C.** No refund will be given as a result of withdrawal after January 15 for fall enrollees or May 15 for spring enrollees.
Note: VA beneficiaries are exempt.
- D.** If you are expelled or dismissed for any reason, no tuition refund will be given.
Note: VA beneficiaries are exempt.
- E.** Tuition paid by another party will be refunded to the paying party unless otherwise stated by the paying party.
- F.** For VA students enrolled under provisions of Title 38 that provide a refund for the unused portion of tuition: In the event the Title 38 student fails to enter the course, withdraws, or is discontinued at any time prior to completion, any unused tuition will be refunded and mailed within 30 days. Tuition is considered used for any month in which you attend class.

9. CHECK CASHING—Under no circumstances will any checks be cashed by the Admissions Office.

10. THIRD-PARTY CHECKS—We are unable to accept third-party checks.

1. TIME AND LENGTH OF COURSES OFFERED

- A. The school year at RBTC is divided into four eight-week quarters. Three class sessions per day are taught: Monday–Wednesday–Friday or Tuesday–Thursday.
- B. **Classes are 50 minutes in length, but a class may occasionally be longer. Therefore, do not commit to be at work before 1 p.m.**
- C. Due to the intensity of the nine-month program of study, all students are enrolled on a full-time basis only. There are no provisions for enrollment of a student on a part-time basis.

2. GRADING SYSTEM

- A. Grading at RBTC is by letter grade and is based on the 4.0 grading system.
- B. Grades are reported to students online through their student accounts. Students cannot request oral reports on grades from the Admissions Office or instructors.
- C. Grades are designated as follows:

<u>Grades</u>	<u>Numeric Scores</u>	<u>GPA Scale</u>
A (Excellent)	90–100	3.6–4.0
B (Good)	80–89	2.6–3.5
C (Satisfactory)	70–79	1.6–2.5
D (Low Pass)	60–69	0.6–1.5
F (Failure)	0–59	0.0–0.5

3. GRADES

- A. Grades are based on scores earned from assignments and exams. Some classes may require papers, projects, quizzes, or reading assignments as part of the grade.
- B. The majority of mid-term and final exams are objective in nature and usually have 25 or 50 questions.

4. CHEATING

- A. Cheating on tests or any other assignment is a violation of the RBTC Student Honor Code. Most importantly, to cheat is to deprive yourself of a learning opportunity.
- B. Any student who is proven to have cheated in any way on his or her schoolwork or tests will be given an “F” in the course and may face dismissal from school.

5. GRADE CORRECTIONS

- A. If you question a grade after final grades have been posted for the term, you have **three school days** to go to the Admissions Office and complete a Grade Correction Form.

Note: Grade Correction Forms may only be submitted for grades listed on that term’s report card at the **end** of each term.

- B. A \$5 fee is charged for **each** grade correction inquiry after investigation. If the grade is correct or if the discrepancy was due to an error on your part, this fee is not refundable.
- C. A \$10 nonrefundable posting fee is charged for each grade correction inquiry for a previous term.
- D. You will be notified when your grade correction request has been reviewed.
- E. Grades can be viewed using your student portal.

6. **REPORT CARDS**—If requested, report cards are furnished at a charge of \$1 per copy.
7. **ASSIGNMENT/EXAM MAKEUP**
- A. A fee of \$15 per assignment/exam is charged for any assignment/exam that is not completed in class due to an absence on the assigned day.
 - B. Makeup **exams** must be completed within two school days following the missed exam. Makeup exams are made available immediately after third hour.
 - C. Makeup **assignments** must be turned in within one week from the due date.
 - D. **There are no makeup exams on final tests for the fourth term.**
 - E. Failure to make up assignments/exams could result in a reduced or failing grade for that class depending on the weight of the assignment/exam.
8. **CLASS ATTENDANCE POLICY**

The goal of students should be to receive the maximum they can from their classes. Receiving a diploma is secondary to being properly prepared for the vocation students have chosen. Therefore, students who exceed the outlined absence guidelines will be dealt with according to the following:

Attendance is **required** in all classes. Any student found skipping classes or student assemblies is subject to discipline by the dean or his appointed representatives.

A. Absences

During each eight-week term, the maximum number of absences permitted will be as follows: **THREE days** of classes that meet on Tuesday and Thursday; **FOUR days** of classes that meet on Monday, Wednesday, and Friday. Exceeding the permitted absences will result in *FAILURE of that course* for non-attendance (FN).

Only the following reasons qualify as excused absences: Exceptions are made for parents when their child's school is closed. Extenuating circumstances such as a death in the family, jury duty, or a medical issue will be considered with approved documentation, such as a funeral program, juror notification, or doctor's note. Students will have the right to appeal and decisions will be made on a case-by-case basis under extenuating circumstances.

B. Tardiness

The attendance beacon will open approximately five minutes before each class begins. You have until the beginning class bell to check in as 'Present.' You should be **SITTING IN YOUR SEAT** at that time. When checking in during the first 10 minutes of class, your attendance will be recorded as 'Tardy.' Checking in more than 10 minutes late is considered 'Absent' and will count against your permitted absences for the term. Receiving three tardies for a course counts as one absence.

If you are tardy, please enter quietly and sit near the back of the classroom.

C. Tuition Absences

Tuition absences are **not** excused. Refer to #3 Tuition Policy on page 16.

D. Ministry Activities

With the exception of RBTC-sponsored events, students will not be excused to participate in ministry or missions outreaches that require absence from classes.

E. Winter Bible Seminar

Attendance at the 10:30 a.m. sessions during *Winter Bible Seminar* is required until noon. Therefore, do not commit to be at work before 1 p.m.

F. Student Responsibilities for Attendance

- (1) **Each day**, you are responsible to confirm **on your own device** that your attendance was recorded for all classes that day. Each hour should show **absent, tardy, or present**.
- (2) If any of your classes for the day do not show an attendance status, you must go to Admissions before leaving campus **that day** to rectify the issue. **No status** (i.e., no attendance taken) will become an **absence**, which will count against your permitted absences for the term.
- (3) It is not permitted to check someone else in or to ask someone else to check you in. This is a violation of the student code of honor and could lead to expulsion.

G. Medical and Maternity Leave Limits—Any student who is absent more than 40 class days, (i.e., eight weeks) because of a severe or emergency medical reason (surgery, outpatient limitations, recovery time, etc.) shall be asked to withdraw from RBTC and reapply the following school year. If the student reenrolls in RBTC, the student must attend the same program from which they withdrew.

If a student is absent from class for less than 40 class days (i.e., eight weeks) because of maternity or medical leave, the student must buy the class recordings of the courses in which they are enrolled, complete all of the reading and assignments, and make up all missed exams by the end of the following term. In the event extended class days are missed during Term 4, special arrangements must be made with the Admissions Office.

H. VA Beneficiary Leave of Absence—VA students who must take a leave of absence from school for any reason (including active duty, maternity leave, etc.) will be terminated effective their last day of attending classes. The date of their return will determine what courses they would need to retake, if any, and what missing work and assignments the student would be responsible for completing.

9. ATTENDANCE PROBATION AND DISMISSAL

The following probation procedure applies to RBTC students who fail one or more courses due to attendance grade reductions.

- A.** The first attendance F may result in the student being placed on probation and remaining on probation through the end of the next term.
- B.** The second attendance F may result in the student being dropped from RBTC.
- C.** See the refund policy on page 17.
- D.** Any student dismissed from school due to attendance violations will not be allowed to reapply until the next enrollment period for the following school year. If accepted, they will be on “Attendance Probation” for a period of time to determine if they are in compliance with attendance requirements.

10. GRADUATION REQUIREMENTS FOR SECOND-YEAR AND ADVANCED STUDIES STUDENTS—To be eligible to receive a diploma from RBTC’s second-year or Advanced Studies programs, a student must meet the following requirements:

- A. All assigned courses must be **satisfactorily** completed for all years of study.
- B. A cumulative grade point average of 2.0 must be maintained for each academic year. (Note: We calculate the GPA using grades from *all* years attended.)
- C. Class attendance requirements as outlined in the handbook must be fulfilled.
- D. Every candidate for graduation must give evidence of a true Christian life and character during the school year at RBTC to be recommended by the faculty for graduation. **Any conduct or lifestyle that is clearly defined by God's Word as being unholy or evil will disqualify a student from graduation.** Refer to pages 30–33 for details on student conduct and honor code requirements.
- E. All outstanding tuition fees and fines must be paid in full before a diploma will be issued.
- F. Attendance at graduation rehearsal and Commencement is **required** of all second-year and Advanced Studies graduates. Permission to graduate in absentia will only be granted by the dean of RBTC in cases of extreme emergency.

11. RHEMA SCHOOL OF MUSIC AND MEDIA ATTENDANCE AND GRADING

A. Attendance

Any student who is absent for more than four sessions of a three-hour course will automatically fail that course. Any student who is absent for more than three sessions of a two-hour course will automatically fail that course.

B. Grading

Any student on academic probation will meet with the dean or his representative.

Any student whose cumulative GPA falls below 2.0 for more than one eight-week session will automatically fail the school year.

Any student who fails more than one course in a given school year automatically fails the entire year. They may reapply the following year and will have to start over.

12. ACADEMIC PROBATION AND DISMISSAL

The following probation procedures apply to students enrolled at RBTC who fall below the required academic average as stated in section 10.

- A. Any first-year student whose cumulative GPA falls below 2.0 or any graduating student whose cumulative GPA falls below 2.6 at the end of any eight-week session will be placed on academic probation.
- B. RBTC reserves the right to terminate the enrollment of a student who is on academic probation.
- C. Refer to the refund policy on page 17.
- D. A student dismissed from school due to academic probation will not be allowed to reapply until the next enrollment period for the following school year.

- 13. **WITHDRAWAL**—The Administration of RBTC takes the matter of student withdrawals very seriously. A student should take this into consideration before submitting a Withdrawal Request.

If circumstances necessitate withdrawal, the following procedures must be adhered to by all students:

- A. Secure a Withdrawal Request Form from the Admissions Office.
- B. Complete the form by *printing* all requested information.
- C. You are required to have a personal interview with the dean or one of his appointed representatives to discuss your reasons for withdrawal. You must secure his or her signature on the form.
- D. You must submit your ID badge and parking permit with your Withdrawal Request Form.
- E. See the refund policy on page 17.

14. TRANSCRIPTS—Transcripts are furnished at a charge of \$5 per copy for each year attended and are issued only if the student's financial accounts are in satisfactory condition. Requests must be made using the online transcript request form at rbtc.org/transcript-request. Please allow seven to 10 business days for the processing of transcript requests.

15. STUDENT FILES AND ACADEMIC RECORDS

- A. RBTC has and maintains student files for all students who attend Rhema Bible Training College. These files are confidential and are not allowed off the Rhema campus, nor is the information therein disclosed to the student.

Note: All files are property of RBTC.

- B. RBTC will allow a student's academic records to be reviewed if requested and when necessary. Requests must be made in writing to Rhema Bible Training College, and a time will be scheduled when a student can do so.

16. ACCREDITATION—RBTC is accredited by Transworld Accrediting Commission International. Serving the Christian education community for over 30 years, Transworld is recognized by the IRS as a non-profit educational organization. TACI is not recognized by the U.S. Department of Education. Their philosophy is to demonstrate accountability to the consuming public for education obtained in nontraditional evangelical educational institutions. RBTC is not accredited through the U.S. Department of Education or the State of Oklahoma and operates as an independent religious educational institution.

TACI oversees more than 140 member institutions, including schools, seminaries, universities, colleges, and institutes both in the United States and internationally. They provide documented evidence of compliance with standards of structure and governance, material resources, policies, faculty, and curriculum. TACI's overall purpose is to promote academic excellence and accountability.

For more information about Transworld Accrediting Commission International, visit TransworldAccrediting.com.

17. TRANSFER OF CREDITS—Rhema Bible Training College cannot award college credit or grant degrees in Oklahoma. Transfer of courses from RBTC to other institutions is at the discretion of the receiving institutions. RBTC is privileged to work with several regionally accredited colleges and

universities that accept RBTC transfer credits into their programs. This offers our students the option of benefitting from their RBTC training when pursuing a formal degree through the following academic institutions:



ASBURY THEOLOGICAL SEMINARY

Tulsa Extension Site
Asbury Development Center
6910 S. 101st E. Ave., Suite 220
Tulsa, OK 74133
844-GO-TO-ATS
asburyseminary.edu

GRAND CANYON UNIVERSITY

3300 W. Camelback Road
Phoenix, AZ 85017
602-247-2068 // Toll-Free: 1-800-800-9776
gcu.edu

NELSON UNIVERSITY

(Formerly Southwestern Assemblies of God University)
1200 Sycamore St.
Waxahachie, TX 75165
972-937-4010 // Toll-Free: 1-888-937-7248
sagu.edu/admissions/partners/sagu-at-rhema

OKLAHOMA WESLEYAN UNIVERSITY

2201 Silver Lake Road
Bartlesville, OK 74006
918-335-6200 // Toll-Free: 1-800-468-6292
okwu.edu

SOUTHEASTERN UNIVERSITY

1000 Longfellow Blvd.
Lakeland, FL 33801
863-667-5000 // Toll Free: 1-800-500-8760
seu.edu

TABOR COLLEGE

400 South Jefferson
Hillsboro, KS 67063
620-947-3121
tabor.edu

TRINITY BIBLE COLLEGE

50 Sixth Ave South
Ellendale, ND 58436
Toll Free: 1-800-523-1603 // Fax: 701-349-5786
trinitybiblecollege.edu

- 18. INDEPENDENT STUDIES**—Per Title 38, CFR 21.4267, Independent Study, students utilizing VA educational benefits at non-college degree (NCD) institutions **may not** use benefits for online training or non-traditional self-paced or flex programs and will not be certified by Rhema Bible Training College.

R H E M A A L M A M A T E R

Standing here today in Your will divine,
I'm reflecting back to a precious time.
I was trained so that to the world I could go.
Rhema taught me what I needed to know.

It's the Word and the Spirit, the sweet Holy Ghost:
A light to the nations, a glorious hope.
I will not forget my foundation:
The years I spent at Rhema.
I've learned the truth, so I'll carry the flame
And I'll go—never the same.

I vow this day to lift the banner high
And to walk in the truth sown into my life.

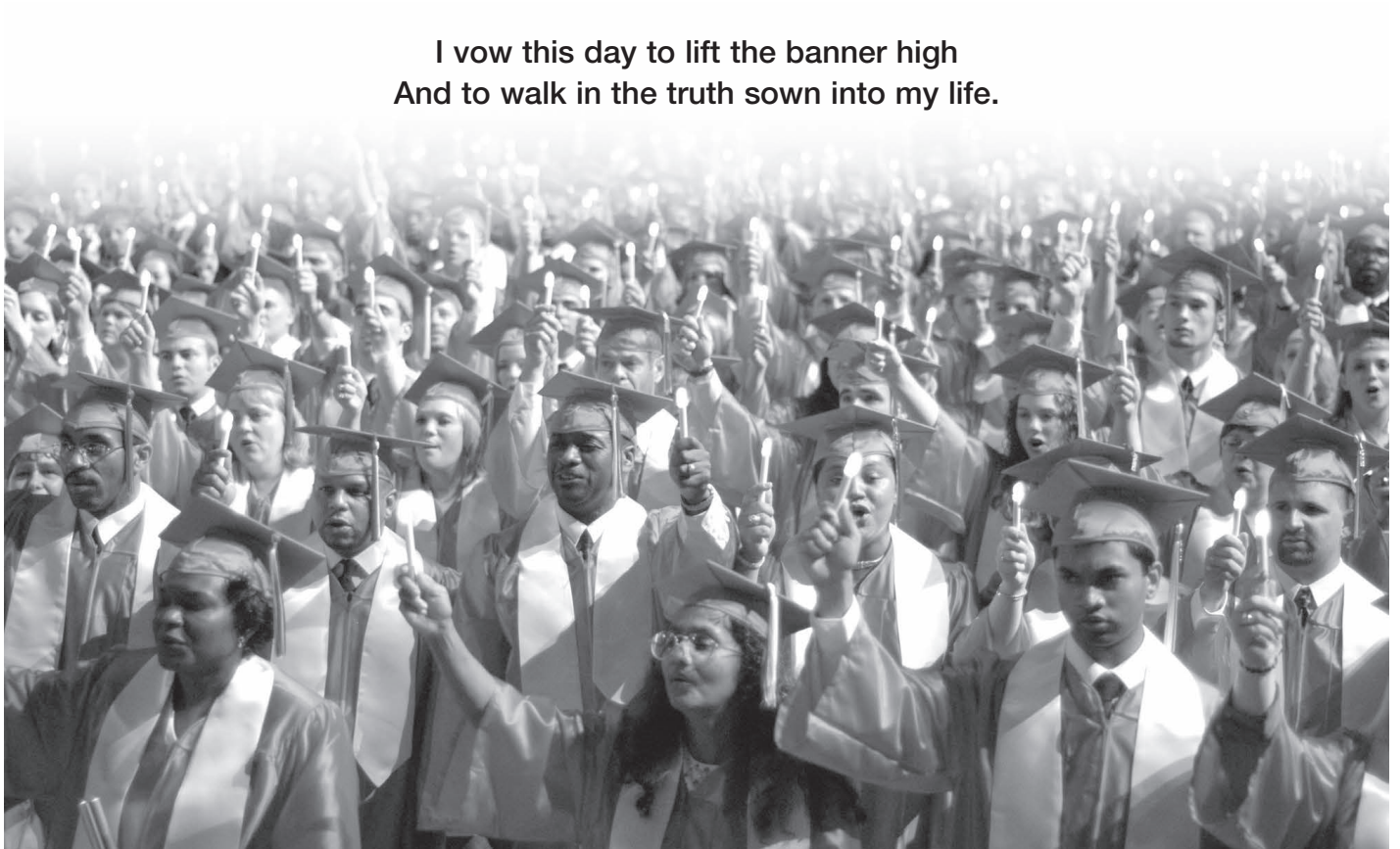

1. MARITAL/FAMILY STATUS

A. Spouse

- (1) If you are married, your spouse **MUST** live with you in the Tulsa area at the time of registration and remain throughout the school year. We will not have any part in the separation of families so you can attend RBTC.
- (2) If for any reason your spouse is apart from you for a period of more than three weeks or is gone on a consistent basis for a week or more at a time, you must notify the Admissions Office immediately.
- (3) If a decision to separate or file for a divorce is made, this must be communicated in writing to the Admissions Office **IMMEDIATELY**. This would include anyone who experiences a separation or divorce between the time their application for RBTC is accepted and school actually begins.

B. Children

- (1) Students are required to report to the Admissions Office whenever a child in their custody departs their residence to establish residence elsewhere. This report would include any children who are in their custody at the time their application is received but are no longer in their custody when school begins.
- (2) It is your responsibility to provide for the health and welfare of your children. You have a responsibility to the child care center and to the day school attended by your children. *Do not enter into the realm of foolishness or presumption.* **Do not take your children to school if they have symptoms of illness.**

C. Getting Married

- (1) RBTC considers it extremely unwise to marry an individual based on a brief courtship and strongly recommends that anyone considering marriage go through extensive premarital counseling prior to getting engaged.
- (2) Further, RBTC strongly urges individuals not to get married during the school year, as this tends to be extremely distracting in terms of receiving the ministerial training that the individual came to RBTC for in the first place.
- (3) While RBTC does not seek to control any person's life, it does sense an obligation to warn students that impulsive marriages and brief courtships have historically resulted in a much higher percentage of serious marital difficulties and a higher rate of divorce, even in cases where individuals were adamant that "God was leading them to get married quickly."
- (4) Further, RBTC believes that if an individual chooses to be impulsive and careless regarding something as sacred and significant as one's choice of a marriage partner, and disregards sound counsel and conventional wisdom on this matter, that individual is demonstrating a lack of patience and steadfastness that is necessary for their later success in ministry.

Therefore, any student who is considering marriage during the course of the school year must meet with the dean or his appointed representatives prior to making any formal arrangements.

2. **UNPAID ACCOUNTS, RENTS, AND FINANCIAL OBLIGATIONS**—We expect all RBTC students to meet all their financial obligations. This is a moral, ethical, and biblical responsibility. If we are notified

of students with unpaid bills, they become subject to dismissal from RBTC, and their diplomas may be withheld until the unpaid bills are taken care of. Their standing with the Alumni Association will also be affected until all outstanding debts are paid.

3. **DRESS CODE**—It is the desire of RBTC that our students are dressed modestly and in good taste. The dress codes outlined below apply at all times *when attending classes and during school hours*:

Note: If you are in violation of the dress code, you will be asked to leave the campus, and you will be counted absent for any missed classes. The dean, any faculty member, or any Admissions Office staff member is authorized to speak to you if you are out of dress code.

A. Women—Acceptable Attire

- Dresses, skirts, collared shirts, blouses, suits, jackets, sweaters, and turtlenecks with dress slacks or jeans (khakis, corduroys, capris of mid-calf length, cropped pants, or gauchos/culottes).
- **Dress/skirt length must be one inch above the knee or longer.**
- **Note:** Shirts, blouses, and sweaters must cover the stomach and midriff area entirely at all times, even when arms are raised.
- Acceptable shoes include dressy sandals, dressy flip-flops, dress shoes, dressy casual shoes, boots, and tennis shoes.

Unacceptable Attire

- **Note:** Any jeans with holes, tears, or rips are not acceptable.
- Tops that are low-cut, revealing, or clingy; spaghetti strap tank tops; graphic T-shirts; and sweatshirts (except for RBTC sweatshirts and T-shirts purchased in the Rhema bookstore).
- Sweatpants, athletic/yoga pants, miniskirts, skorts, shorts, and leggings.
- Gothic attire or extreme accessories.
- Head coverings such as hats, caps, stocking or toboggan caps, bandannas, etc.

B. Men—Acceptable Attire

- Dress or casual slacks, khakis, corduroys, Dockers-type slacks, or jeans. (Slacks must be worn at the waist. No baggy or saggy pants or jeans are allowed.)
- Collared shirts, oxfords, polos, or sport shirts *with collars* may be worn. Ties are optional. Sweaters and turtlenecks, vests, blazers, sport coats, and suits are also acceptable.
- **Note:** Shirts may not have advertisements, excessive designs, wording, or logos on them, with the exception of approved Rhema clothing.
- Tennis shoes, dress shoes or dressy casual shoes with socks.
- Beards and mustaches must be kept clean and groomed.
- Hair must not extend much below the TOP of the shirt collar and must not cover more than half the ear, or touch the eyebrows. Hair **MUST** be neatly groomed and well-kept.

Unacceptable Attire

- **Note:** Any jeans with holes, tears, or rips are not acceptable.
- Sweatpants, shorts, or athletic pants.
- T-shirts of any style, or sweatshirts (except for RBTC sweatshirts and T-shirts purchased in the Rhema bookstore).
- Flip-flops, sandals, or slides.
- Gothic attire or extreme accessories.
- Head coverings such as headbands, hats, caps, stocking or toboggan caps, bandannas, etc.
- Excessive hair length, or extreme colors or styles.
- False or painted nails.

4. STUDENT ID BADGES—The student ID badge grants access to the classroom and the NRC. **You may not attend class without your ID for any reason.**

- A.** Each student is given a student identification badge bearing their legal name, student number, and photograph.
- B.** **This badge must be worn at the collar area in plain sight or on a lanyard at all times when on campus during class hours.** Your badge will be checked by a door monitor each day as you enter each classroom. Anyone finding a lost ID badge should turn it in to the Admissions Office promptly.
- C.** After registration, you must have your ID badge with you when making all tuition payments.
- D.** Any time you come to the Admissions Office to conduct any business, please have your ID badge with you. Also, any correspondence to the dean or the Admissions Office **MUST** have your ID number on it.
- E.** Nothing is to be taped, pinned, stapled, or attached to your ID in any way.
- F. If you FORGET your ID Badge, you have two options:**
- (1) Leave the campus, locate your ID, and return to school. (You will be counted absent for any classes missed.)
 - (2) Go to the Admissions Office and purchase a temporary ID for \$2. It will be good for **THAT DAY ONLY.**
- G. If you have permanently lost your ID badge:**
- Go to the Admissions Office and pay \$8 for a new ID. A complimentary ID will be issued on a daily basis until your new ID is ready. Fees for new IDs are nonrefundable.
- H.** Student ID badges are considered the property of RBTC and are to be returned at the end of the school year or when a student withdraws from school.

5. **NONDISCRIMINATORY POLICY**—RBTC admits students of any race, color, or national and ethnic origin to all rights, privileges, programs, and activities generally accorded or made available to students at the school. We do not discriminate on the basis of race, color, or national and ethnic origin in administration of educational policies, admissions policies, and athletic or other school-administered programs.

6. **CLASS VISITATION GUIDELINES**

A. Current students are allowed to bring guests to visit RBTC.

B. To visit RBTC classes, a guest **must be at least 16 years old**.

C. Rhema Alumni Association members are to contact the Alumni Office for proper class visitation procedures.

D. A guest may visit for two days per term.

E. Students who want to bring a guest to class must obtain an RBTC Guest Information Request Form from the Forms Table in the SDC 1 lobby.

F. The student's responsibilities for bringing a visitor to class are as follows:

(1) Submit an RBTC Guest Information Request Form.

(2) Inform the visitor of dress code requirements and class rules.

(3) Bring the visitor to the Admissions Office on the morning of the visit to obtain a Guest Pass for the visitor.

(4) Introduce your guest to the RBTC recruiter after the third-hour class.

G. The visitor's responsibilities for visiting a class are as follows:

(1) Follow dress code requirements and class rules.

(2) Sit with the student host.

(3) Stay with the student host at all times.

(4) Wear the Guest Pass at all times.

7. **CLASSROOM/CAMPUS REGULATIONS**

A. **Offerings**—No offerings or funds for any reason shall be collected on the RBTC campus. The only exception to this rule is the collection for the class gift by the student body. The date(s) of this collection will be selected and authorized by the director and dean of RBTC.

B. **Announcements**—*No one* is allowed to make announcements in the classrooms except the Hagins, the dean, instructors, and the Admissions Office staff.

C. **Audio Equipment/Thermostats**—Do not touch *any* audio/video equipment or thermostats. This includes microphones, cameras, television sets, sound booth, etc. If there is a temperature or sound problem in a class, contact the head monitor. Do not attempt to correct the problem yourself.

D. **Notebook, Laptop, or Tablet Computers**

(1) Power cords may not be plugged in. Computers, phones, and tablets must run on their own batteries.

- (2) RBTC is not responsible for the safety or security of computers brought by students. Bring your computer at your own risk.
- (3) Note-taking is the only permissible use of computers in the classroom.
- (4) No audio or digital recording of class sessions (or any portion of a class session) is allowed.

E. Cell Phones

- (1) Phones must be placed on silent ring or turned off upon entering the classroom.
- (2) Sharing information electronically while in class by text messaging, IM, AirDrop, email, Bluetooth, or any other means is prohibited.
- (3) No audio or digital recording of class sessions (or any portion of a class session) is allowed.

F. Cameras—Cameras are prohibited in classrooms.

G. Recording Devices—*NO* digital recorders or other recording devices are allowed in the classrooms at any time.

H. Dry-Erase Boards—No student may write on or use dry-erase boards for any reason whatsoever unless authorized to do so by an instructor.

I. Class Notes—Each student is responsible for taking their own notes. Class notes are not to be sold to any other students, but may be borrowed by students to copy for studying when classes are missed due to sickness or other absences for good causes. Violation of this policy may be grounds for dismissal from school.

J. Distractions—Silence all electronic devices and refrain from using them for anything non-class related. Refrain from distracting activities of any kind such as popping gum, cutting nails, tapping pencils, putting feet on chairs, continual verbal comments, using shaker cups, opening noisy snack packaging, and other bothersome habits or actions.

K. Children—A student's child is not allowed in the classrooms and may not be left unsupervised in the Admissions Lobby.

L. Possession or Use of Weapons—Rhema Bible Training College strictly prohibits the possession or use in any form, of what could be identified as an (offensive) weapon on campus property. This policy refers to and identifies (but is not limited to) guns, knives, brass knuckles, clubs, chemical agents (such as pepper spray and Mace), or any other device or instrument that could be used as an offensive weapon. Any violation of this policy will result in immediate disciplinary action including possible dismissal as a student from Rhema Bible Training College.

M. Flyers/Handbills—No one is allowed to distribute any flyers, tracts, advertisements, coupons, or any other material of *any* kind to fellow students or employees, or to place them on any vehicles on campus. Please inform the Admissions Office *immediately* if you see any activity of this kind taking place.

N. Student Mail/Deliveries—Do not list the address of RBTC or Rhema Bible Church aka Kenneth Hagin Ministries, Inc., as your personal address. Any student's mail received in this manner will automatically be returned to the sender.

O. Telephone Calls—RBTC will not accept incoming calls for any students except in extreme emergencies.

P. Classroom Furniture—Do not disconnect the chairs and move them around the classroom.

- 8. RHEMA BIBLE CHURCH EMBLEMS**—All RBTC students should understand that the Rhema Bible Training College Seal, *The Sword*, the Faith Shield, Rhema Bible Church, Rhema Ministerial Association International, Rhema YTH, Rhema Kids, Rhema Regals, Rhema Synergy, *Kindle the Flame*®, *A Call to Arms*®, and Rhema Alumni Association logos, the name “Rhema Bible Training College,” and the names *The Word of Faith*, *Living Faith Conferences*, *Rhema for Today*, and *Rhema Praise* are names and symbols registered under Rhema Bible Church, aka Kenneth Hagin Ministries, Inc. They are not to be used in any way for advertising, personal logos, or as names of organizations set up by RBTC graduates. RBTC graduates can state, of course, that they have graduated from RBTC, but that is the extent to which the name can be used. Please do not request permission to use these names or logos in any fashion, as it will not be granted.



- 9. RHEMA PARK REGULATIONS**—The Rhema Park is for the use of RBTC students, employees, and their accompanied guests, or for functions of Rhema Bible Church and Kenneth Hagin Ministries. To reserve and schedule use of the park, contact the Ninowski Recreation Center at 918-258-1588, ext. 2301.

Regulations are as follows:

- No Pets Allowed
- No Open Fires
- No Vehicles (Including Bicycles, Scooters, Skates, and Skateboards)
- No Camping
- No Fishing
- No Smoking
- Park Closes at 10 p.m.
- Children under 12 must be attended by an adult 18 or older.

10. STUDENT CONDUCT

- A.** Christian character is an important concern of RBTC. It is the responsibility of the student engaged in training at RBTC to live an exemplary life.

“Abstain from every appearance of evil” (1 Thess. 5:22 MKJV).

“Do you not know that the unrighteous shall not inherit the kingdom of God? Do not be deceived; neither fornicators, nor idolaters, nor adulterers, nor abusers, nor homosexuals, nor thieves, nor covetous, nor drunkards, nor revilers, nor extortioners, shall inherit the kingdom of God. And such were some of you. But you are washed, but you are sanctified, but you are justified in the name of the Lord Jesus, and by the Spirit of our God” (1 Cor. 6:9–11 MKJV).

“Now the works of the flesh are clearly revealed, which are: adultery, fornication, uncleanness, lustfulness, idolatry, sorcery, hatreds, fightings, jealousies, angers, rivalries, divisions, heresies, envyings, murders, drunkennesses, revelings, and things like these; of which I tell you before, as I also said before, that they who do such things shall not inherit the kingdom of God” (Gal. 5:19–21 MKJV).

- B. Students must be diligent and responsible in meeting their financial obligations.
- C. It is expected that students will avoid practices and forms of entertainment that are detrimental to personal growth in the Christian life.
- D. Public displays of affection such as kissing, hugging, massaging backs, and so forth, are not considered appropriate on-campus behavior.
- E. **The administration of RBTC will not allow students to live immorally at any time because God has plainly stated that He disapproves of immorality.**

Therefore, RBTC will not allow any type of physical or sexual activity/behavior other than what the Bible states is permitted for a husband and wife who are legally married.

This includes, but is not limited to, homosexual activities, fornication, adultery, pornography, and so forth which are immoral behavior and are not permitted. Social dancing of a suggestive nature and the use of tobacco, e-cigarettes, intoxicants (including wine or beer), or habit-forming or illegal drugs are also considered inappropriate behavior and are not permitted.

- F. Violence or threats toward fellow students, instructors, or other Rhema personnel will NOT be permitted at any time.
 - G. Any student found actively involved in any of the above will be subject to immediate dismissal from school.
11. **DISCIPLINE OF STUDENTS**—The dean or his appointed representatives will handle any discipline problems that may arise. Any student who is found to be acting in a manner that brings discredit to the Kingdom of God and/or RBTC will be disciplined, even to the extent of suspension or expulsion from RBTC. Any student expelled or dismissed from school for such violations will not be allowed to reapply to Rhema.
12. **STUDENT HONOR CODE**—Upon the completion of training at RBTC, a student will receive a diploma that states:

*This Certifies That
(Your Name)*

*Has Satisfactorily Completed a
Two-Year Ministerial Training Course
and Has Complied With All the Requirements
Necessary for This Diploma.*

***Note:** Verbiage is subject to change.

This diploma will be signed by Rev. Kenneth W. Hagin and Rev. Lynette Hagin. To have “satisfactorily completed” the course and have “complied with all the requirements necessary” to graduate from

RBTC involves more than attending classes and getting a passing grade on exams. You may successfully complete a math course at another school by doing the assignments and passing the exams, but a course of Bible study and ministerial training requires significantly more.

When you are called to the ministry and commit yourself to God's Word, God lays claim on every aspect of your life. It is a 24-hour-a-day commitment, and it applies personally, relationally, vocationally, socially, financially, and intellectually. Therefore, much is expected of you in the classroom and beyond.

The real certification each student must pursue is to one day hear Jesus say, "Well done, My good and faithful servant." The real test that must be passed is not one given in the classroom but the test of life.

We ask that you look beyond the rules of RBTC and live life by a much higher principle. The rules are designed to encourage and promote a certain level of discipline. However, to be truly successful in life and ministry, one must have far more than an external compliance to rules or an externally motivated discipline. Each student must cultivate an internal discipline, sense of conviction, motivation, and consecration within himself. Such a person does not seek to "do just enough to get by" or judge themselves by the performance of others. Instead, they offer their utmost to God, with conscientiousness and wholehearted dedication to the task at hand.

It is in this spirit that the RBTC Code of Honor is written. It is not designed to be an external rule, but rather, to reflect and articulate the heartfelt commitment of an individual who is sincerely and genuinely seeking to be all that God wants him to be.

The RBTC Student Honor Code

I. In My Personal Life

- A.** I will seek to obey God's Word and glorify Him in every way.
- B.** I commit to conduct myself in such a way as to be a good witness for Jesus Christ and a positive reflection of RBTC.
- C.** I will be a person of honesty and integrity in all my dealings with others.
- D.** I will keep my total being under subjection and will abstain from all illegal and sexually immoral acts, as well as from tobacco, alcohol, illegal drugs, and any other action or substance that is inappropriate for the temple of the Holy Spirit.
- E.** I will dress modestly and avoid places, practices, and associations that are inappropriate for a Christian preparing for ministry.
- F.** I pledge to faithfully attend to my financial obligations and live within my income as a good steward and will not carelessly leave unpaid debts behind me.
- G.** I recognize my responsibility to be a positive influence and encourage spiritual growth in the lives of others. I will avoid any behavior that would be detrimental to or a negative influence upon others.

II. As a Student

- A.** I will be respectful toward the administration, faculty, and support staff of RBTC at all times.

- B. I will submit to and obey all rules, policies, and guidelines set forth by RBTC.
- C. I will diligently apply myself to my studies and seek to achieve optimal spiritual and intellectual benefit from my training.
- D. I commit to exercising every effort to maintain excellent attendance and punctuality. This commitment extends not only to classes but also to all RBTC assemblies and special seminars.
- E. I will be honest on all exams and assignments and will avoid any form of cheating, fraud, or plagiarism.
- F. I will avoid any conduct that is detrimental to the learning process of others, both inside and outside of the classroom.
- G. I will attend church services on a regular and consistent basis and will seek to faithfully serve in my local church.

13. SEXUAL AND OTHER HARASSMENT POLICY—Rhema Bible Training College does not and will not condone violations of students' rights to be free of unlawful harassment. Students are expected to comply with this policy and take appropriate measures to ensure that such unlawful harassment conduct does not occur. All complaints of unlawful harassment will be promptly, thoroughly, and confidentially investigated, and when necessary, appropriate corrective action will be taken. Any person found to have unlawfully harassed another student will be subject to appropriate disciplinary action, up to and including dismissal from school.

Definitions of Harassment:

- Any verbal or physical conduct that threatens, intimidates, or coerces another student, either directly or indirectly.
- Verbal taunting (including racial and ethnic slurs).
- Any unwelcome sexual advances, requests for sexual favors, and other verbal or physical conduct of a sexual nature when such conduct interferes with a student's attendance at RBTC or creates an otherwise offensive or "hostile" environment.

Sexual harassment DOES NOT refer to behavior or occasional compliments of a socially acceptable nature. Sexual harassment DOES refer to behavior that is unwelcome, personally offensive, lowers morale, and/or interferes with work effectiveness. Sexual harassment may take different forms, such as a "demand for sexual favors."

Examples of sexual harassment include but are not limited to:

- Verbal: Sexual innuendoes, suggestive comments, jokes of a sexual nature, sexual propositions or threats.
- Non-Verbal: Sexually suggestive objects or pictures, graphic commentaries, suggestive or insulting sounds, leering, whistling, or obscene gestures.
- Physical: Unwanted physical contact including touching, pinching, brushing the body, coerced sexual intercourse, or assault.

Reporting Harassment Complaints:

School policy states that all complaints and reports of harassment must be immediately reported and documented. The complaint and investigation results are taken seriously and held in strict confidence. Any student who feels that they are a victim of harassment should immediately report the matter or incident to the Admissions Office at 918-258-1588, ext. 2260.

AUTO, TRAFFIC & PARKING INFORMATION

1. SECURING PARKING PERMITS

- A.** All students attending RBTC must obtain a parking permit for motor vehicles and motorcycles during orientation. Student employees of Rhema Bible Church, RBTC, and/or Kenneth Hagin Ministries are required to have both a student parking permit and an employee parking permit.

Parking permits are issued only after satisfactory arrangements have been made for payment of tuition and fees.

You must have a current parking permit to park on the RBTC campus.

- B.** The state law of Oklahoma **requires** that you carry proof of liability insurance and your automobile registration in your automobile at all times.

Proof of liability insurance, or proof that the student is covered under their parents' policy, is also required to obtain a parking permit.

- C.** Additional parking permits may be secured from the Admissions Office. Every vehicle a student owns or uses that will be parked on campus must have a parking permit, or the student will be fined.

- D.** All parking permits remain the property of RBTC. When a vehicle is sold, traded, or junked, you must *first* remove the permit and bring it to the Admissions Office. When a vehicle is purchased, a new permit will be issued upon request when required information is furnished.

- E.** Parking permits are valid through the last day of classes. Vehicles left on campus during the summer months, Thanksgiving or Christmas holidays, or spring break will be impounded and stored at the owner's expense.

- F.** Should your car have an RBTC Parking Permit from any previous school year, it **MUST** be removed and returned to the Admissions Office.

- G.** Permits must be affixed (DO NOT USE TAPE) to the outside of the *rear window* (lower left corner, driver's side) on automobiles (position #1 in the drawing). On motorcycles, permits must be affixed to the front fork on the right arm (right arm is determined by seated position). This must be done before bringing the vehicle to school as you will be responsible for any tickets issued for lack of a parking permit.

Note: Many newer-model cars have wraparound rear windows. Looking at the rear of the car, place the permit on the lower left-hand side of the window on the flat part of the glass surface just before the wraparound curve.

Should your vehicle **not** have a rear window (vans, pickups, convertibles, etc.), place the sticker on the back bumper to the **left of the license plate**.

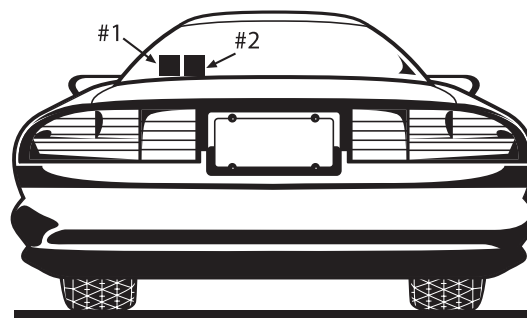

H. In addition to the student parking permit, students living in RBTC Student Housing **must have an RBTC Student Housing permit**, which is issued by that office. It must be placed **to the right of the student parking permit** (position #2 in drawing). Student Housing parking permits are valid through August 31.

2. TRAFFIC AND PARKING REGULATIONS

A. All vehicles must be parked head *in* only.

B. Park only in sections with *yellow lines* and only *between* yellow lines. (This does not apply to Rhema Bible Church services.)

C. *Blue-lined* sections are reserved for employees or guests only. *Do not park in these areas*. This is in effect campus-wide from 8 a.m. to 5 p.m., Monday through Friday. Students who are also employees must not park in blue-lined sections during school hours.

D. You must have a handicapped parking permit to park in the handicapped areas.

E. Do not park along curbs. Do not drive or park on sidewalks.

F. Do not block entrances or the flow of traffic at any time.

G. Nonresident students *may not* park at RBTC Student Housing during class time, seminars, church services, or any special meetings. Violators will be fined.

H. Students may not park their cars across the street at businesses or on a side street.

I. The *permit holder* is responsible for all violations and charges made against the holder's permit number, regardless of who is driving at the time of the violation.

J. Special parking is designated for two-wheeled vehicles. Refer to campus map on page 46.

K. Traffic regulations will be enforced at all times during classes and activities relating to RBTC.

L. Speed Limit—15 mph on campus; 10 mph at Student Housing.

3. VIOLATIONS AND PENALTIES

A. Violations are subject to fines, including the towing of vehicles from RBTC property. Fines are \$5 per citation and must be paid at the Admissions Office. RBTC fines do not include the cost of commercial towing. Present the pink ticket when paying fines.

B. All tickets must be paid within **five school** days. Failure to pay the ticket is grounds for suspension, and/or dismissal from school.

4. ADDITIONAL INFORMATION

A. Any student needing their vehicle towed from campus **must first notify the Security Office. (918-607-1289)**

B. Major vehicle repairs are not allowed while the vehicle is parked on RBTC property. (*Exception: Minor adjustments to get the vehicle removed from RBTC property are permitted only after notifying the Security Office.*)

1. **LIBRARY HOURS**—TBA
2. **LIBRARY DRESS CODE**—Casual dress, but **NO SHORTS** are permitted. Shirts and shoes are required.
3. **CONDUCT**—The Library is to be a quiet place; therefore, **loud talking** will not be tolerated. Failure to obey this rule may result in the students involved being asked to leave and possible loss of Library privileges. No food or uncovered drinks are allowed in the Library. Covered drinks are permitted.
4. **LIBRARY PRIVILEGES**
 - A. RBTC students, alumni, and employees and their spouses—but no other friends or relatives—are allowed to use the Library.
 - B. A student ID badge must be presented to enter the Library and check out materials. You may check out no more than five books and no more than three media items.
 - C. No more than five items can be checked out at one time. Media items are due in two weeks. The fine for late media items is 25 cents per day per item, with a \$5 maximum fine per item.
 - D. Books are due in two weeks. The fine for late books is 10 cents per day per book, with a \$1 maximum fine per book.
 - E. Failure to return items on time will result in fines and loss of borrowing privileges.
 - F. A book may be renewed if no one else has entered a request for it. Renewed books are subject to recall if requested by another student.
 - G. Reference books may not be checked out.
5. **LOST OR DAMAGED BOOKS**—RBTC Library's policies for lost or damaged books are as follows:
 - A. If the book is still in print, the student will be charged for the cost of the book and any acquired fines, plus a \$10 processing fee.
 - B. If the book is out of print, the student will be charged for the cost of finding another copy of the book and any acquired fines, plus a \$10 processing fee. As the borrower, **YOU** are **RESPONSIBLE** to see that your book is returned on time.
6. **CHILDREN**—No children under age 14 are allowed in the library.

For information or questions, please call 918-258-1588, ext. 2260.

THE NINOWSKI RECREATION CENTER (NRC) provides facilities for entertainment and recreation for students, church members, staff, and their families. It also offers a place of fellowship and an opportunity to meet new friends. The NRC coffee bar is open for students before and after school. The full-service food court offers daily specials where students and their families can enjoy a nice meal in a fun atmosphere. For recreation, the NRC provides basketball, volleyball, and racquetball courts, a running track, and a weight room. Locker rooms are equipped with lockers, saunas, and showers. Locks are not provided for the lockers but are recommended. A roller skating rink is located in the west part of the building. The NRC is part of the RBTC campus; therefore, proper conduct and attire are required. The NRC phone number is 918-258-1588, ext. 2301.

1. NRC HOURS

Monday, Tuesday, Thursday
7 a.m.–9 p.m.

Wednesday, Friday
7 a.m.–3 p.m.

Saturday
9 a.m.–3 p.m.

At certain times, the NRC will be closed for various church activities. Check the church bulletin/Canvas announcements for closings and special announcements.

2. GYM USE

- A. A person must be at least 14 years of age or accompanied by an adult. (***The adult must remain on the premises*** during the child's entire visit to the NRC.)
- B. Present your ID badge to the receptionist. (ID badges may be purchased for \$5 for family members.) ID badges must be worn while in the gym.
- C. Wear proper shoes and workout attire:
 - (1) Proper workout attire includes sweats and other modest apparel.
 - (2) Shorts must be at least 3/4 length.
- D. No guests are allowed.

3. INTRAMURAL SPORTS PROGRAM—A number of intramural sports programs are available to RBTC students. Details concerning the following programs will be announced during Thursday assemblies and posted on Canvas:

- Coed Pickleball League
- Coed Softball League
- Coed Volleyball League
- Coed Basketball League
- Coed Soccer League
- Coed Ultimate Frisbee League

For more information concerning the intramural sports program, contact the Sports Office at 918-258-1588, ext. 2303.

4. **NRC SKATING RINK**—The NRC Skating Rink is a great place for families and students to come for a time of fun, food, and fellowship.
 - A. Our family skating sessions, held throughout the year from 6:30 to 9 p.m., provide a positive atmosphere for the whole family. Kids of all ages will have a good time eating pizza and playing video games.
 - B. For people 18 years old and older, there are monthly Late Skates from 10 p.m. to 1 a.m. with contemporary Christian music, music videos on flat-screen TVs, and great fellowship.

STUDENT MP3 INFORMATION

CLASS MP3s ARE FOR THE INDIVIDUAL STUDENT ONLY. Class MP3s are prohibited from being sent, loaned, or given to anyone else. This includes any past, present, or future Rhema students. Violation of this policy could cause the discontinuance of the class MP3-production service for the entire student body. Students may only make copies of their class MP3s for their personal use to listen to them on another device and to back them up. Current RBTC students are allowed to purchase class MP3s for another current RBTC student. All class MP3 inquiries must be directed to the SDC 1 Media Sales Area or the Media Duplication Department at 918-258-1588, ext. 2243.

1. GENERAL GUIDELINES FOR ORDERING CLASS MP3s

A. Where and When to Order

Orders will be taken at the SDC 1 Media Sales Area located in the Lobby of SDC 1 at the following times:

After Class (M-W-F) 11:20 a.m.–12:05 p.m.
(T-TH) Noon–12:45 p.m.

B. What You May Order

You may order individual MP3s or course subscriptions of RBTC classes taught during the current school year. First-year students may order MP3s of first-year Ministry Fundamentals courses they are currently enrolled in or have completed.

Second-year and GES students may order MP3s of first- and second-year Ministry Fundamentals courses they are currently enrolled in or have completed if the course is being taught or has been taught during the current school year at the time the order is placed.

Advanced Studies students may order MP3s of any first- and second-year Ministry Fundamentals course that is being taught or has been taught during the current school year at the time the order is placed. They may also order MP3s of the Advanced Studies courses they are currently enrolled in or have completed. They may not order MP3s from any Advanced Studies specialty program other than the one in which they are currently enrolled.

C. How to Order

Order only one item per order form (i.e., one individual class MP3 or one subscription set). Order forms may be picked up at the SDC 1 Media Sales Area. Please take only the forms required for your current order.

The student must complete the order form accurately with the correct course number, date of class, etc. When filling out RBTC MP3 Order Forms, please press hard with a ballpoint pen so that the information on the bottom copy is legible.

Payment must be made at the time the order is placed. Present the order form at the SDC 1 Media Sales Area with your payment and student ID badge. Cash, check, money order, Visa, Discover, American Express, and MasterCard are acceptable forms of payment.

After payment is made, you will receive the bottom portion of the order form, the pink slip. That will be your claim check, which you must have with you when picking up your RBTC USB drives.

2. INDIVIDUAL CLASS MP3s

A. To Order Individual Class MP3s:

Individual MP3s—\$5 each, plus tax.

Individual MP3 orders may be placed during any term within the current school year. Orders placed within two class days from the date a lesson is taught will be given the discounted price of \$3.50 (plus tax). Orders placed after two class days from the date a lesson is taught will cost the normal price of \$5 (plus tax).

Examples:

Monday Classes—Orders will be taken through Wednesday at 12:05 p.m. at a discounted price of \$3.50 per MP3. After Wednesday, all orders for Monday classes will be taken at the normal price of \$5 per MP3 (plus tax).

Thursday Classes—Orders will be taken through Monday at 12:05 p.m. at a discounted price of \$3.50 per MP3. After Monday, all orders for Thursday classes will be taken at the normal price of \$5 per MP3 (plus tax).

You may not order more than one MP3 of any class. This means if you order a subscription, you cannot order additional single MP3 of that class. The only exception to this rule is lab classes, which may be ordered in any quantity.

Be sure to write on the order form the correct lesson date of the single class MP3 you are ordering and your correct email address. If you write the incorrect lesson date or email address, you will delay the fulfillment of your order.

B. To Receive Your Individual Class MP3s:

A restricted link to download your individual class MP3(s) will be sent to the email address provided on the order form within one week after the order is placed.

This link will be good for seven days and will be restricted to your email address that was provided on the order form. The link will not work if the email is forwarded to any other address.

3. CLASS MP3 SUBSCRIPTIONS

A. To Order Class MP3 Subscriptions:

Class Subscription Regular Prices

(M-W-F) \$70 each, plus tax

(T-TH) \$50 each, plus tax

These are set prices for M-W-F or T-TH subscriptions regardless of the number of MP3s in each subscription, during the term in which the courses are taught. Each subscription comes on an RBTC USB drive.

MP3 subscription orders placed within the first three weeks of the term in which the courses are taught are given a discount of \$10 each. The discounted price of a M-W-F subscription is \$60, and the discounted price of a T-TH subscription is \$40.

You may order only one subscription of any course. If you have purchased single MP3s of a class and then decide to order the subscription of that class, bring the pink slips of the single MP3s with you to the SDC 1 Media Sales Area at the time you place your order for the subscription. You will be given credit toward the price of the subscription for the single MP3s already purchased.

When placing an order during the term that a course is taught, the student must indicate on the order form whether the subscription MP3s will be received weekly (once a week) or at the end of the term. Once you have indicated on the order form the method of receiving your MP3s, you will not be allowed to change it. If the method of receiving your MP3s (weekly or end-of-term) is not indicated, you will automatically receive your subscription at the end of the term.

B. To Receive Your Class MP3 Subscriptions:

(1) Weekly Subscriptions

The USB drive(s) for your weekly subscription(s) will be available for pick up at the SDC 1 Media Sales Area within one week after the order is placed.

Your claim check (pink slip) must be presented at the SDC 1 Media Sales Area for pickup. At that time, you will receive a USB drive containing the MP3s available for your subscription up to the time your order was placed.

Once a week, for the remainder of the term, a restricted link to download that week's class MP3s will be sent to the email address provided on the order form.

This link will be good for seven days and will be restricted to your email address that was provided on the order form. The link will not work if the email is forwarded to any other address.

(2) End-of-Term Subscriptions

For Terms 1–3, the USB drive(s) for your end-of-term subscription(s) ordered during the current term in which the courses are taught will be available at the SDC 1 Media Sales Area starting the next class day following the end of the term.

The USB drive(s) for your end-of-term subscription(s) of courses taught during Term 4 will be available at the SDC 1 Media Sales Area the last two days of the term.

Your claim check (pink slip) must be presented at the SDC 1 Media Sales Area for pickup.

(3) Subscriptions Ordered From Previous Terms

The USB drive(s) for your subscriptions(s) of courses taught during previous terms will be available in the SDC 1 Media Sales Area within two weeks after the order is placed.

4. PICK-UP DEADLINES

- A. For Terms 1–3, students are asked to pick up their USB drives within one week after the end of the term in which the order was placed.
- B. Any USB drives not picked up within two days after the end of Term 4, regardless of when the order was placed, will be considered abandoned. To receive USB drives after this deadline, students will be required to contact the Media Duplication Department to pay shipping charges and arrange for their USB drives to be mailed to them.

5. CURRENT CLASS MP3 INFORMATION

- A. Students are responsible to be aware of all current class MP3 information, such as deadline dates, special announcements, etc.
- B. Current class MP3 information will be listed on Canvas. Please read posted announcements. You are responsible for the information contained there.

6. LOST CLAIM CHECKS AND DEFECTIVE USB DRIVES/MP3s

- A. If you lose your claim check (pink slip), you must go to the SDC 1 Media Sales Area and complete a special form. After one class day, you must return to pick up your USB drive(s).
- B. Check your USB drive(s) and MP3(s) immediately. If a USB drive or MP3 is defective, it can only be replaced within 60 days from the date it was purchased.
- C. Note: We do not loan MP3s or give free MP3s to students due to absences or missed deadlines.

7. SEMINAR INFORMATION

- A. MP3s of *Winter Bible Seminar* will be offered to students at a discount. Ordering details will be provided in the student announcements the week following the seminar.
- B. You may purchase only one MP3 set on a USB drive or one of any single MP3 at the student discount price. If you wish to obtain more than one, you must order additional USBs/MP3s at the full price.

RBTC MP3 Order Form Samples

Sample #1: Ordering Complete M-W-F Subscription

RHEMA BIBLE TRAINING COLLEGE

Name: John DoeEmail: Johndoe@gmail.com 1st yr 2nd yr Adv. Studies Today's date 09 / 16 / 24

COURSE # T H E 1 0 6 MWF TTH
 CLASS NAME: Faith Library I SUBSCRIPTION:
 INSTRUCTOR: Kenneth W. Hagin END OF TERM _____ WEEKLY X
 HOUR: 1 2 3 TERM: 1 2 3 4 SINGLE: DATE ____/____/____

For MDD use only: CA ____ CK ____ CR ____ RC ____ Total Amount Due _____

MDD 15.9-8/24

Sample #2: Ordering Complete T-TH Subscription

RHEMA BIBLE TRAINING COLLEGE

Name: Jane DoeEmail: Janedoe@gmail.com 1st yr 2nd yr Adv. Studies Today's date 09 / 17 / 24

COURSE # F I N 1 0 1 MWF TTH
 CLASS NAME: Financial Management SUBSCRIPTION:
 INSTRUCTOR: Craig W. Hagin END OF TERM X WEEKLY ____
 HOUR: 1 2 3 TERM: 1 2 3 4 SINGLE: DATE ____/____/____

For MDD use only: CA ____ CK ____ CR ____ RC ____ Total Amount Due _____

MDD 15.9-8/24

Sample #3: Ordering Single Class MP3s

RHEMA BIBLE TRAINING COLLEGE

Name: Jim DoeEmail: Jimdoe@gmail.com 1st yr 2nd yr Adv. Studies Today's date 11 / 13 / 24

COURSE # S O C 1 0 1 MWF TTH
 CLASS NAME: Marriage, Family & Ministry SUBSCRIPTION:
 INSTRUCTOR: Kenneth & Lynette Hagin END OF TERM _____ WEEKLY ____
 HOUR: 1 2 3 TERM: 1 2 3 4 SINGLE: DATE 11 / 11 / 24

For MDD use only: CA ____ CK ____ CR ____ RC ____ Total Amount Due _____

MDD 15.9-8/24



RHEMA ALUMNI ASSOCIATION (RAA)—Membership in the Rhema Alumni Association is available to all Rhema USA graduates. RAA is a way for you to have access to all things Rhema. During the spring of your second year, you'll receive a FREE one-year RAA membership. After that, you'll be sent a membership renewal form every year to renew on your own.

For a minimal yearly membership fee, the benefits of being a Rhema Alumni Association member include:

- access to the alumni portion of the Rhema website (including the job database/ministerial opportunities) at rhema.org/alumni
- class visitation privileges—five days each quarter
- access to NRC for members visiting from out of town
- alumni audit program (for more information contact RBTC Admissions)

RAA is how you can stay connected.
rhema.org/alumni
 @rbtcalumni

**You attend RBTC for two, three, or four years,
 but you're part of the Rhema family for life!**

**We want to stay in touch with you—so be sure we
 always have your updated email address and contact info!**

For more information, contact RAA/RMAI at 918-258-1588, ext. 2256,
 or at raa@rhema.org,
 or drop by the offices on the south side of SDC 2.



RHEMA MINISTERIAL ASSOCIATION INTERNATIONAL (RMAI)—RMAI is the credentialing branch of Rhema Bible Church.

Qualifications: Ministerial credentials are available through the RMAI organization for any graduate serving in the following ministry positions: pastor, assistant pastor, music minister, youth minister, children’s minister, chaplain, missionary, itinerant minister, home missionary (American Indian reservation), or other (which is at the discretion of the RMAI leadership).

One of the qualifications for receiving credentials through RMAI after graduation is to have been an *active member* of Rhema Bible Church while you were a student.

For more detailed information on credentialing qualifications, go to rhema.org/alumni and click on RMAI Application under Quick Links.

If you have any questions about the qualifications, please contact the RAA/RMAI office.

TO APPLY: RMAI applications are available online, or you may also contact the Alumni Office for an application packet. The application fee is \$175.

Church Planting pastors should contact the RMAI Office for Church Planting Procedures before starting a church.

RMAI OFFERS:

- Ministerial licensing and ordination to qualified graduates
- Regional and District Directors
- Accountability and fellowship
- Regional retreats, district gatherings, etc.
- Ministerial opportunities
- Church Affiliation
- Handling of funds for missionaries

1. **RCA (Rhema Church Auditorium)**—the main church auditorium where students attend Exaltation throughout the school year.
2. **Rhema Bible Church Office**—students who want to meet with the pastoral staff will contact the Church Office.
3. **RCDC (Rhema Child Development Center)**—Oklahoma’s largest daycare facility. RCDC is located in Rhema Bible Church on the east side of the building.
4. **SDC 1 (Student Development Center 1)**—RBTC’s first official classroom building. It contains two large classrooms (1278 and 3456), the Recruiting and Admissions departments, and a VA breakroom.
5. **SDC 2 (Student Development Center 2)**—houses six classrooms (201, 203, 205, 209, 211 & 213), the on campus Nelson University (SAGU) office, Alumni & RMAI offices, Alumni & RMAI offices, the Missions office, and Synergy.
6. **Library and Security Office**—the library and security office are located on the first floor. The Rhema School of World Missions and the Rhema School of Music and Media classrooms are on the second floor. It also houses Rhema Regals, a church program for young girls.
7. **MAC (Multipurpose Activity Center)**—contains an auditorium and facilities for the church youth program and young adult group. Several Student Ministries classes are held in this building.
8. **Administration Building**—houses the HR, Data Processing, Partner Services, Accounting, Communications, and IT departments.
9. **RMA (Rooker Memorial Auditorium)**—was the original RCA before the existing church was built.
10. **NRC (Ninowski Recreation Center)**—contains a basketball court, volleyball court, racquetball courts, workout room, running track, roller skating rink, and snack bar. Available to all students, as well as church members and their families.
11. **We-Care Center**—used for collecting and distributing food, clothing, and other items to people in need.
12. **FAC (Fellowship Activity Center)**—used for various school and church functions as needed.
13. **RSH (Rhema Student Housing)**—96 apartment units available to students on a first-come basis.
14. **Motorcycle Parking**
15. **MSC (Maintenance Service Center)**—houses Shipping & Receiving, Maintenance, and Grounds departments.

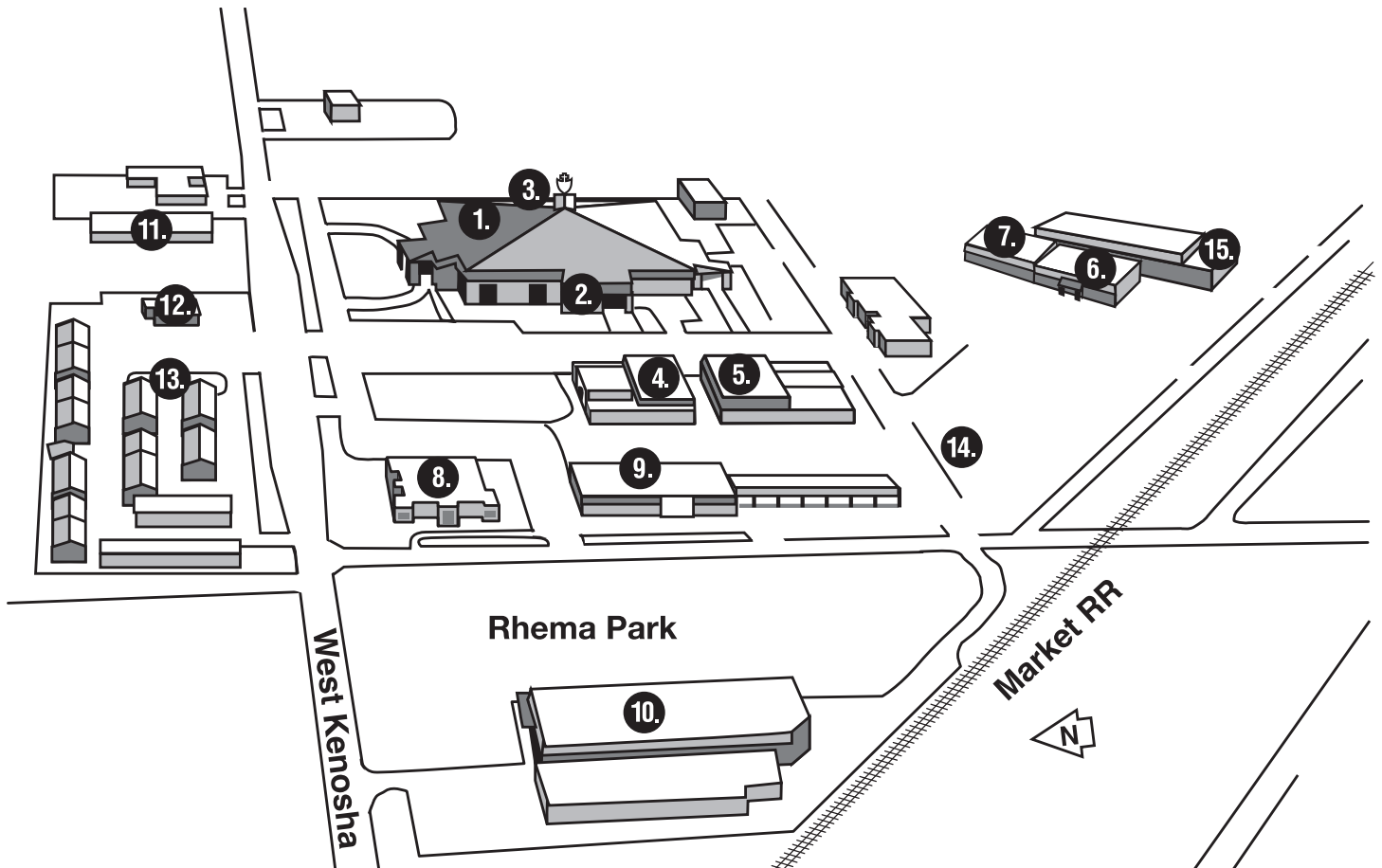

Kenneth Hagin Ministries Campus Map

- | | |
|---|--|
| 1. Rhema Bible Church Auditorium (RCA) | 8. KHM Administrative Offices
Human Resources |
| 2. Rhema Bible Church Office | 9. Rooker Memorial Auditorium (RMA) |
| 3. Rhema Child Development Center (RCDC) | 10. Ninowski Recreation Center (NRC) |
| 4. Student Development Center 1 (SDC 1)
RBTC Admissions | 11. We-Care Center |
| 5. Student Development Center 2 (SDC 2)
RBTC Alumni Offices and Synergy | 12. Fellowship Activity Center (FAC) |
| 6. Library and Security Office | 13. Rhema Student Housing |
| 7. Multipurpose Activity Center (MAC)
Rhema Youth and Rhema Young Adults | 14. Designated Motorcycle Parking |
| | 15. Maintenance Service Center (MSC) |

STUDENT DEVELOPMENT CENTER 1 (SDC 1)

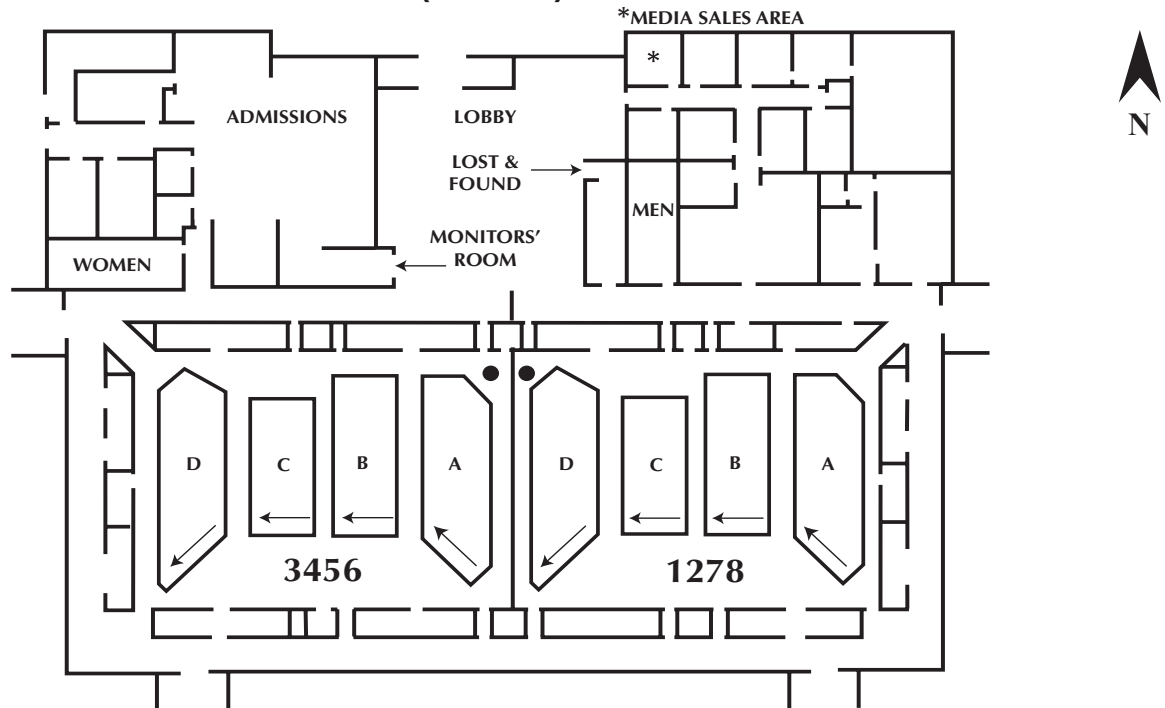

STUDENT DEVELOPMENT CENTER 2 (SDC 2—Downstairs)

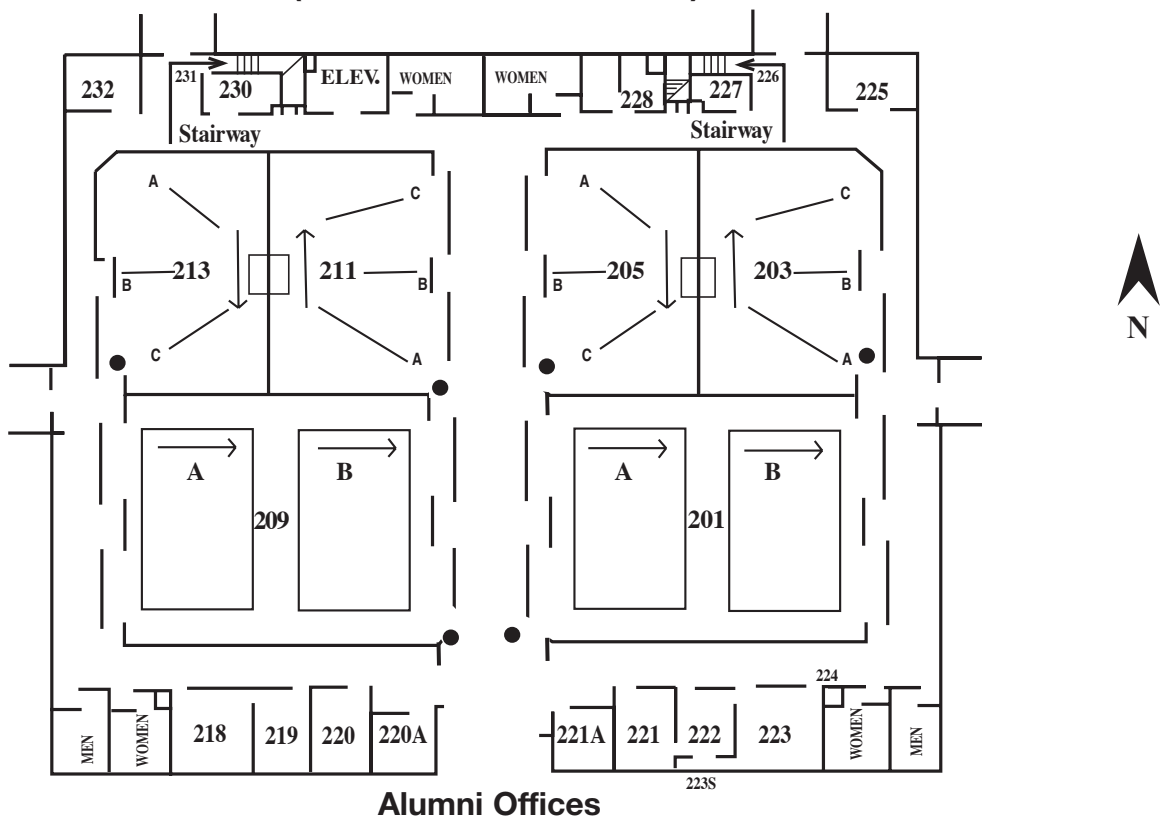

- Dots indicate the late doors where tardy students are to enter and where the Head and/or Assistant Head Monitor are to be seated.

STUDENT DEVELOPMENT CENTER 2 (SDC 2—Upstairs)

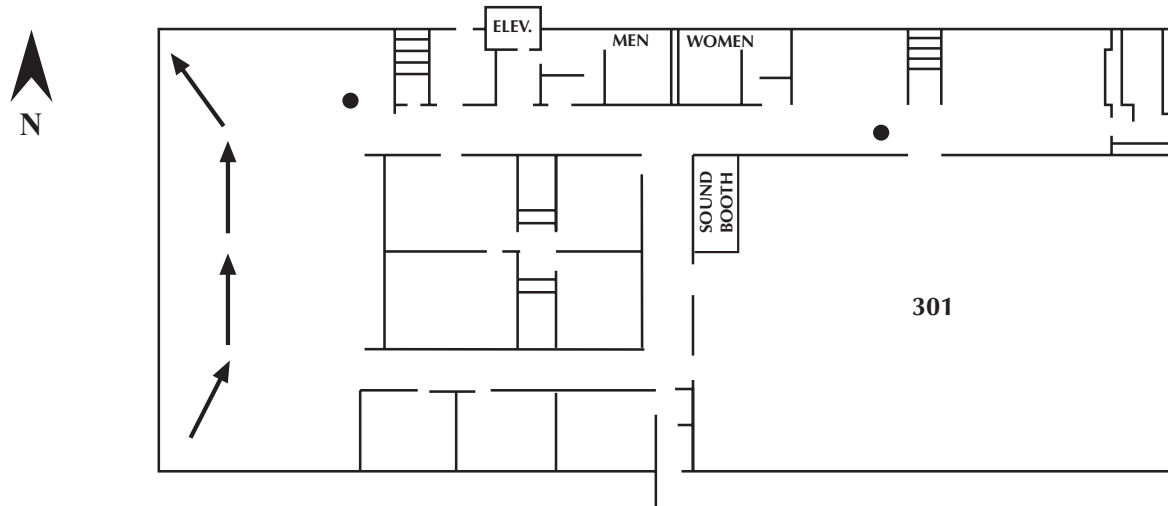

- Dots indicate the late doors where tardy students are to enter and where the Head and/or Assistant Head Monitor are to be seated.

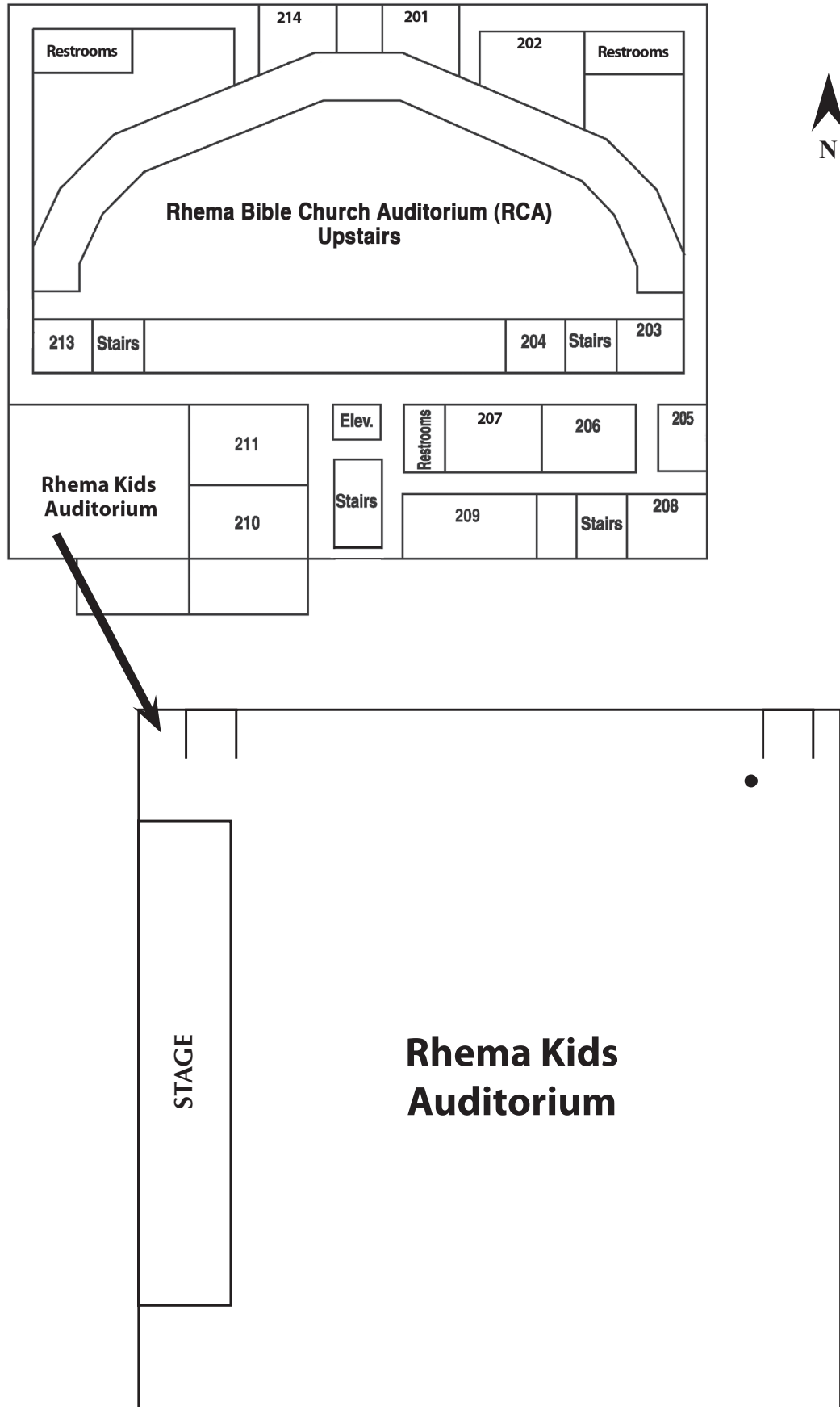

- Dots indicate the late doors where tardy students are to enter and where the Head and/or Assistant Head Monitor are to be seated.